

SlashPRO™ SLASH RESISTANT CLOTHING CATALOGUE 2017

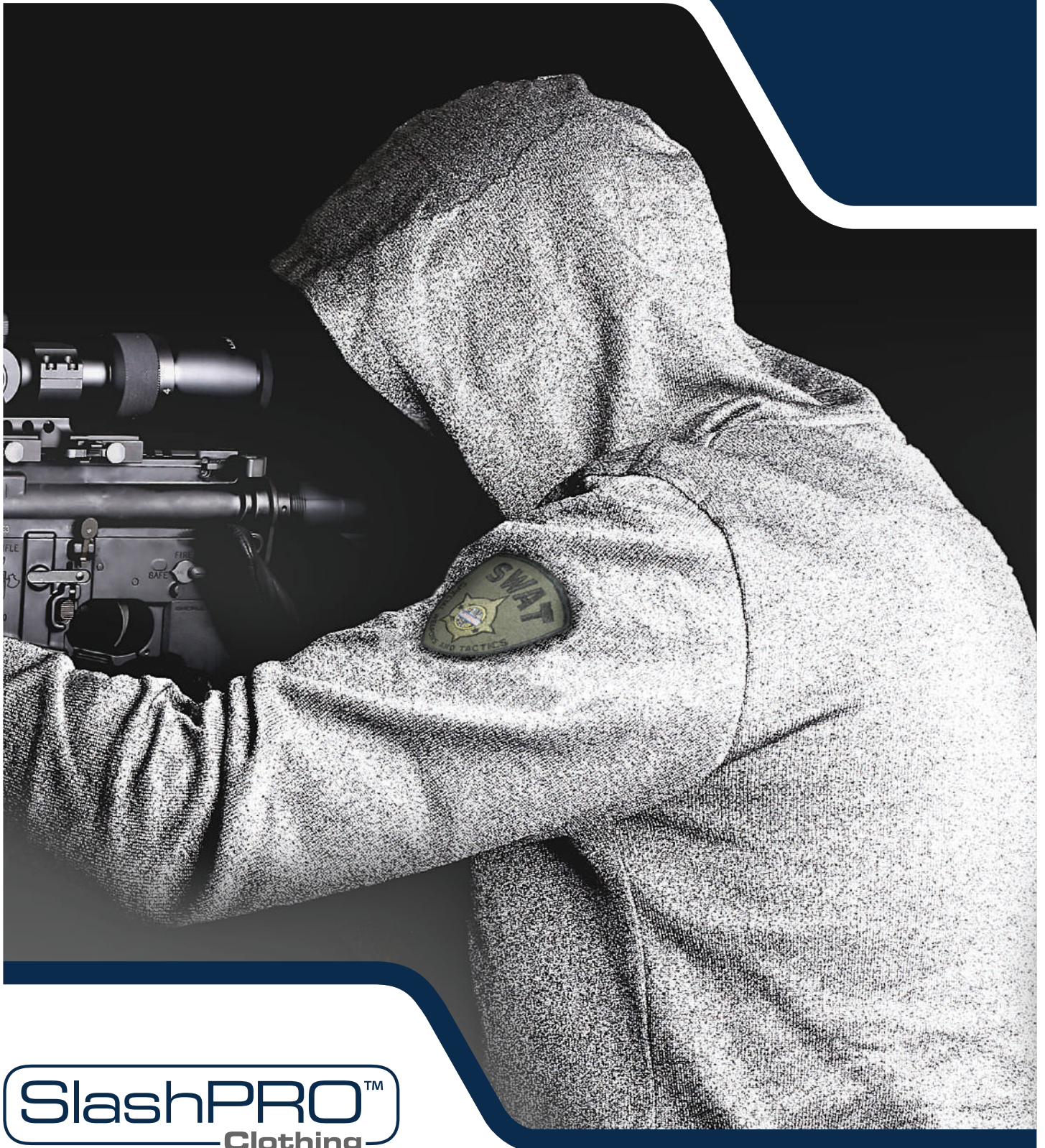

SlashPRO™
Clothing

Contents

2. Introduction – SlashPRO™ Arm Guards & Clothing

3. About Cut-TEX® PRO

PRODUCTS

UPPER BODY

4. SlashPRO™ Slash Resistant Polo T-Shirt

5. SlashPRO™ Slash Resistant Polo Sweatshirt

6. SlashPRO™ Slash Resistant V-Neck T-Shirt

7. SlashPRO™ Slash Resistant V-Neck Sweatshirt

8. SlashPRO™ Slash Resistant Turtleneck Jacket

9. SlashPRO™ Slash Resistant UBAC Shirt

10. SlashPRO™ Slash Resistant Hoodie with Kangaroo Front Pocket

11. SlashPRO™ Slash Resistant Turtleneck Sweatshirt with Thumbholes

12. SlashPRO™ Slash Resistant Neck Guard

13. SlashPRO™ Slash Resistant Body Armour Base Layer

14. SlashPRO™ Slash Resistant Balaclava

LOWER BODY

15. SlashPRO™ Slash Resistant Boxer Shorts

16. SlashPRO™ Slash Resistant Long Johns

ARM GUARDS

17. SlashPRO™ Slash Resistant Arm Guards V1

18. SlashPRO™ Slash Resistant Arm Guards V1 with Added Protection

19. SlashPRO™ Slash Resistant Arm Guards V2

20. SlashPRO™ Slash Resistant Arm Guards V3

21. SlashPRO™ Slash Resistant Arm Guards V4

22. SlashPRO™ Slash Resistant Arm Guards V4 with Added Protection

23. SlashPRO™ Slash Resistant Arm Guards V5

GLOVES

24. SlashPRO™ Slash Resistant Gloves - Ares

25. SlashPRO™ Slash Resistant Gloves - Ares Long

26. SlashPRO™ Slash Resistant Gloves - Hera

27. SlashPRO™ Slash Resistant Gloves - Heracles

28. SlashPRO™ Slash Resistant Gloves - Titan

29. SlashPRO™ Slash Resistant Gloves - Classic

30. SlashPRO™ Slash Resistant Gloves - Nemesis

31. Contact

SlashPRO™ Clothing

The risk of being slashed with a weapon is very much a reality for professionals working within hostile environments namely, homeland security, prison and correctional facilities and in law enforcement.

SlashPRO™ Arm Guards & Clothing can effectively help reduce the risk of such injuries, offering BS EN 388:2003 blade cut resistance level 5.

Slash related injuries can of course become infected and, even worse, lead to potentially life threatening injuries through blood loss. Equally, life changing physical injuries could occur which could ultimately be prevented.

This is not to mention the psychological trauma this could cause long term to the individual staff member who sustains such injuries.

SlashPRO™ is the ultimate protection in the fight against this ever increasing problem. Staff assaults are on the increase within such environments, so it pays to protect staff against the very worst case scenarios.

Whilst the focus is very much on potential attacks against staff, it may be that, indirectly, staff are required to attend an incident of self-harm, where they are then potentially exposed to risk of attack and a slashing of some description occurring.

“ I performed multiple tests on the durability of the SlashPRO™ shirt. I utilized straight and serrated blades while testing the shirt. I did not have any success piercing through the arms or shoulder area of the shirt. I believe the shirt works very well for its intended purpose.”

- Deputy Henry Schneider - Santa Rosa County Sheriff's Office - Team Leader / Emergency Response Team - Tactical Corrections Operator

Why is SlashPRO™ Clothing So Important?

- Attacks in prisons are on the increase. There were 5,423 assaults on prison staff in the 12 months to the end of March 2016 - a rise of 40% on the previous year. This is only likely to increase further over the coming years.
- Attacks on police officers, who sustained injury, topped 7,903 in 2015. This was from a total of 23,000 reported to Health and Safety departments within police forces in the UK.
- In the USA, the FBI conducted a survey in 2013 on the number of officers assaulted with knives/blades. These were higher than the amount of attacks using firearms. This number has increased year on year up to the present day.
- According to the 2013 Correctional Officer Wellness and Safety Literature Review, correctional officers are involved in the highest amount of non-fatal violent encounters than any other occupation.
- A study by the National Institute of Justice in 2007, discovered there are approximately 2,000 correctional staff member injuries annually due to violence against officers by inmates.
- The BBC in the UK reported on 16th April 2014 that the number of serious attacks on prison officers by inmates increased by 45% in two years, figures released by Labour have revealed. In 2012, a total of 543 assaults on prison officers were referred to the police – up from 374 in 2010.
- A 2015 study in the U.S. concluded that for every 10,000 full-time Corrections Officers, there were 254 workplace assaults and violent injuries reported in 2011 that's 36 times the rate for all American workers. In 2013, 15 workplace fatalities of correctional workers were reported nationwide, in a workforce of nearly 470,000 people.
- On 27th February 2016 the UK based Mirror Newspaper claimed that prisoners have assaulted more than 1,000 prison officers in just two months. These include 95 of the highest category 'serious' assaults on staff, such as being slashed with homemade weapons. The two monthly totals is equivalent to more than 16 prison officers being attacked each day. The figures show that 905 officers were victims of the lesser 'assault' during this period. This represented a surge of 15 per cent.



SlashPRO™ Slash Resistant Polo Sweatshirt



Visit our website: www.slash-pro.com

T: +44 (0) 845 5193 953 | E: info@slash-pro.com

About Cut-Tex[®] PRO



Cut-Tex[®] PRO is an ultra-high performance cut, bite and slash resistant fabric, comfortable to wear, fully machine washable and of truly exceptional strength and durability - making it the ideal material for SlashPRO[™] Clothing.

As you can see below, Cut-Tex[®] PRO performs very highly in all cut, tear and abrasion tests:

Cut-Tex[®] PRO Performance Charts:

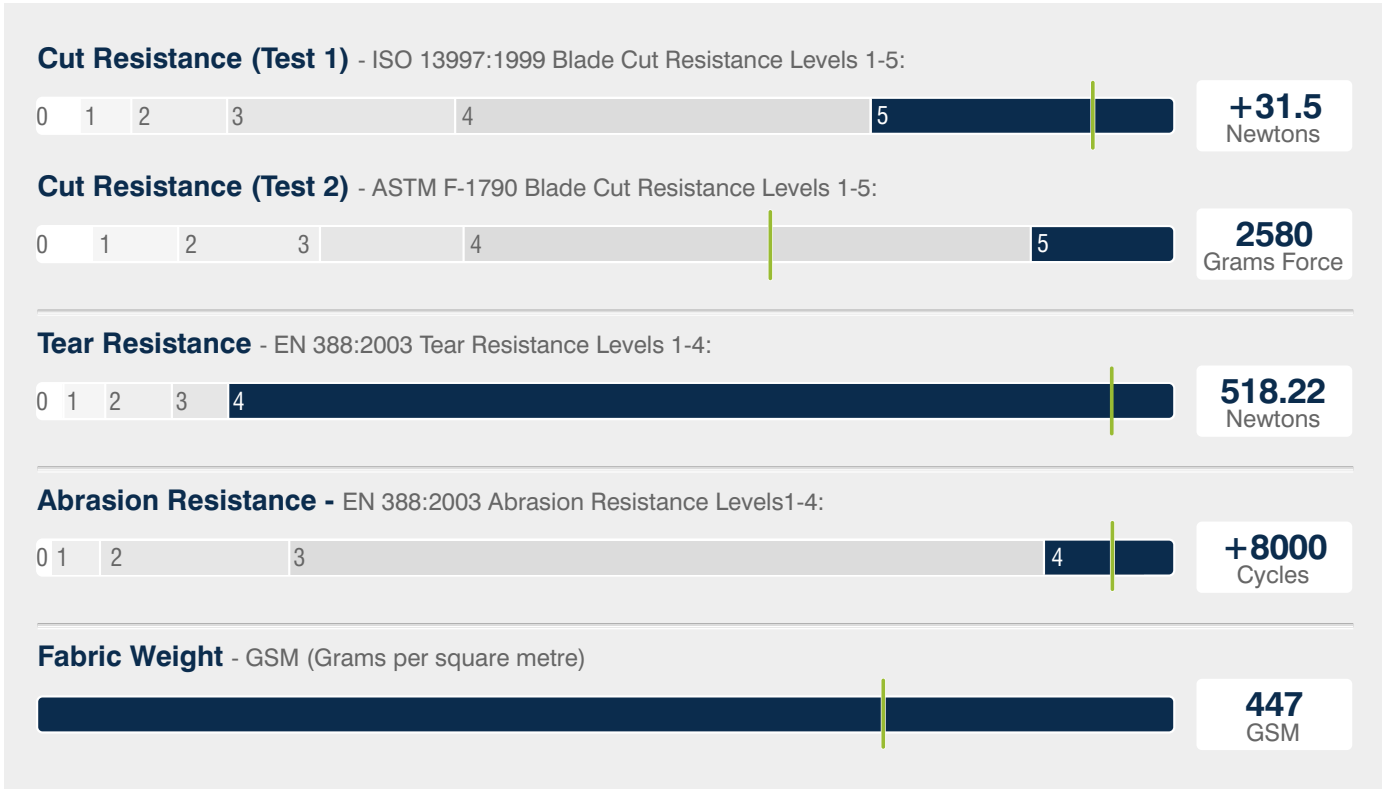

Visit our website: www.slash-pro.com

T: +44 (0) 845 5193 953 | E: info@slash-pro.com

Product: **SlashPRO™ Slash Resistant Polo T Shirt**

Model #: **100104**



SlashPRO™ Slash Resistant Polo T-Shirts are manufactured using Cut-Tex® PRO - offering absolutely outstanding, tested and certified levels of cut, abrasion and tear resistance.

Features & Benefits

- Cut-Tex® PRO used on the entire garment providing excellent cut and slash resistance
- 100% Latex free

Who Is This Product Suitable For?

Professionals working within these sectors:

- Law Enforcement
- Military
- Corrections / Prison Service
- Immigration
- Customs
- Border Control
- Private Security & Military Contractors
- Civil Enforcement

Material Content 100% Cut-Tex® PRO

Blade Cut Resistance

EN 388:2003 Level 5 (the highest possible)

ISO 13997:1999 Level 5 (the highest possible)

ASTM F 1790-05 Level 4

Abrasion Resistance

EN 388:2003 Level 4 (the highest possible)

Tear Resistance

EN 388:2003 Level 4 (the highest possible)

Dimensional Stability Test Achieved excellent results

CE Marking Cat II PPE Directive

Sizes S - 2XL

Clothing Care Machine washable up to 40° Celsius

Colour Grey

Place of Manufacture EU

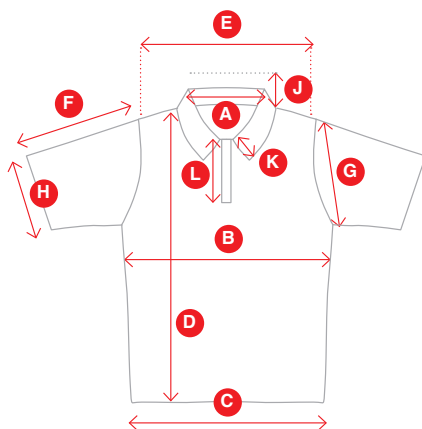

	Description	S	M	L	XL	2XL
A	Neck Width	16.5	17	17.5	18	19
B	Chest	46	50	54	58	62
C	Hem	47	51	55	59	63
D	Front Body*	70	72	74	75	76
E	Shoulder Width	44	46	48	50	52
F	Sleeve Overarm	21	22	23	24	25
G	Arm Opening/Hole	25	26	27	28	29
H	Sleeve Cuff Opening	15.5	16	17	18	19
J	Back Collar height**	7.5	7.5	7.5	7.5	8
K	Front collar edge	6	6	6	6	6.5
L	Placket Length	15.5	15.5	15.5	16	16
M	Placket Width	3	3	3	3	3

All measurements are taken flat in centimetres. All measurements are approximate and offered as a guideline only.
*Length from neck point to hem. **Fully open.

Product: **SlashPRO™ Slash Resistant Polo Sweatshirt**

Model #: **100105**



SlashPRO™ Slash Resistant Polo Sweatshirts are manufactured using Cut-Tex® PRO - offering absolutely outstanding, tested and certified levels of cut, abrasion and tear resistance.

Features & Benefits

- Cut-Tex® PRO used on the entire garment providing excellent cut and slash resistance
- 100% Latex free

Who Is This Product Suitable For?

Professionals working within these sectors:

- Law Enforcement
- Military
- Corrections / Prison Service
- Immigration
- Customs
- Border Control
- Private Security & Military Contractors
- Civil Enforcement

Material Content 100% Cut-Tex® PRO

Blade Cut Resistance

EN 388:2003 Level 5 (the highest possible)

ISO 13997:1999 Level 5 (the highest possible)

ASTM F 1790-05 Level 4

Abrasion Resistance

EN 388:2003 Level 4 (the highest possible)

Tear Resistance

EN 388:2003 Level 4 (the highest possible)

Dimensional Stability Test Achieved excellent results

CE Marking Cat II PPE Directive

Sizes S - 2XL

Clothing Care Machine washable up to 40° Celsius

Colour Grey

Place of Manufacture EU

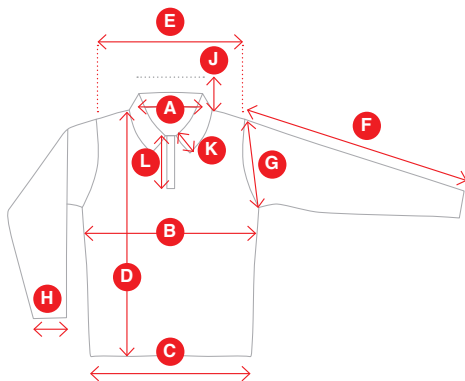

	Description	S	M	L	XL	2XL
A	Neck width	16.5	17	17.5	18	19
B	Chest	46	50	54	58	62
C	Hem	47	51	55	59	63
D	Front body*	70	72	74	75	76
E	Shoulder width	44	46	48	50	52
F	Sleeve overarm	60	61	62	63	64
G	Arm opening/hole	25	26	27	28	29
H	Sleeve cuff opening	11	11	12	12	12.5
J	Back collar height**	7.5	7.5	7.5	7.5	8
K	Front collar edge	6	6	6	6	6.5
L	Placket length	15.5	15.5	15.5	16	16
M	Placket width	3	3	3	3	3

All measurements are taken flat in centimetres. All measurements are approximate and offered as a guideline only.
*Length from neck point to hem. **Fully open.

Product: **SlashPRO™ Slash Resistant T Shirt**

Model #: **100108**



SlashPRO™ Slash Resistant T-Shirts are manufactured using Cut-Tex® PRO - offering absolutely outstanding, tested and certified levels of cut, abrasion and tear resistance.

Features & Benefits

- Cut-Tex® PRO used on the entire garment providing excellent cut and slash resistance
- 100% Latex free

Who Is This Product Suitable For?

Professionals working within these sectors:

- Law Enforcement
- Military
- Corrections / Prison Service
- Immigration
- Customs
- Border Control
- Private Security & Military Contractors
- Civil Enforcement

Material Content 100% Cut-Tex® PRO

Blade Cut Resistance

EN 388:2003 Level 5 (the highest possible)

ISO 13997:1999 Level 5 (the highest possible)

ASTM F 1790-05 Level 4

Abrasion Resistance

EN 388:2003 Level 4 (the highest possible)

Tear Resistance

EN 388:2003 Level 4 (the highest possible)

Dimensional Stability Test Achieved excellent results

CE Marking Cat II PPE Directive

Sizes S - 4XL

Clothing Care Machine washable up to 40° Celsius

Colour Grey

Place of Manufacture EU

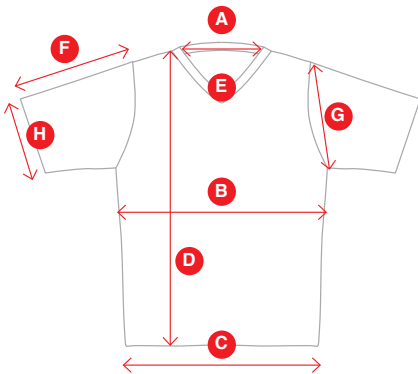

Description	S	M	L	XL	2XL	3XL
A Collar	15	16	17	18	19	20
B Chest	50	52	54	56	60	64
C Hem	51	53	55	57	61	65
D Front body	64	66.5	69	71.5	74	76.5
E Shoulder width	43	46	49	52	55	58
F Sleeve overarm	21	22	23	24	25	26
G Arm opening/hole	20	21	23	24	26	27
H Sleeve cuff opening	16	18	20	22	23	24

All measurements are taken flat in centimetres. All measurements are approximate and offered as a guideline only.

Product: **SlashPRO™ Slash Resistant Sweatshirt (Long Sleeve)**

Model #: **100109**



SlashPRO™ Slash Resistant Sweatshirts are manufactured using Cut-Tex® PRO - offering absolutely outstanding, tested and certified levels of cut, abrasion and tear resistance.

Features & Benefits

- Cut-Tex® PRO used on the entire garment providing excellent cut and slash resistance
- 100% Latex free

Who Is This Product Suitable For?

Professionals working within these sectors:

- Law Enforcement
- Military
- Corrections / Prison Service
- Immigration
- Customs
- Border Control
- Private Security & Military Contractors
- Civil Enforcement

Material Content 100% Cut-Tex® PRO

Blade Cut Resistance

EN 388:2003 Level 5 (the highest possible)

ISO 13997:1999 Level 5 (the highest possible)

ASTM F 1790-05 Level 4

Abrasion Resistance

EN 388:2003 Level 4 (the highest possible)

Tear Resistance

EN 388:2003 Level 4 (the highest possible)

Dimensional Stability Test Achieved excellent results

CE Marking Cat II PPE Directive

Sizes S - 4XL

Clothing Care Machine washable up to 40° Celsius

Colour Grey

Place of Manufacture EU

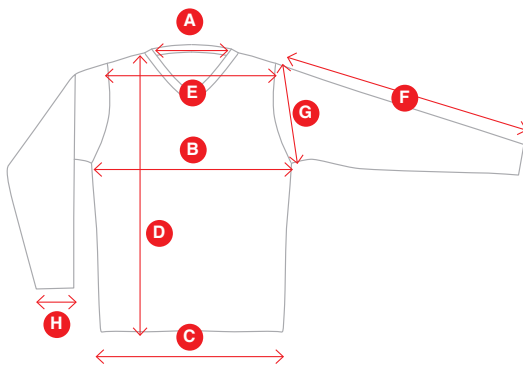

Description	S	M	L	XL	2XL	3XL
A Collar	15	16	17	18	19	20
B Chest	50	52	54	56	60	64
C Hem	50	52	54	56	60	64
D Front body	64	66.5	69	71.5	74	76.5
E Shoulder width	43	46	49	52	55	58
F Sleeve overarm	56	57	58	59	61	62
G Arm opening/hole	20	21	23	24	26	27
H Sleeve cuff opening	10	11	12	13	14	15

All measurements are taken flat in centimetres. All measurements are approximate and offered as a guideline only.

Product: **SlashPRO™ Slash Resistant Turtleneck Jacket**

Model #: **100117**



SlashPRO™ Slash Resistant Jackets are manufactured using Cut-Tex® PRO - offering absolutely outstanding, tested and certified levels of cut, abrasion and tear resistance.

Features & Benefits

- Cut-Tex® PRO used on the entire garment providing excellent cut and slash resistance
- High neck prevents neck and vertebral arteries from being exposed
- Zipped front makes this garment more user friendly
- 100% Latex free

Who Is This Product Suitable For?

Professionals working within these sectors:

- Law Enforcement
- Military
- Corrections / Prison Service
- Immigration
- Customs
- Border Control
- Private Security & Military Contractors
- Civil Enforcement

Material Content

100% Cut-Tex® PRO

Blade Cut Resistance

EN 388:2003	Level 5 (the highest possible)
ISO 13997:1999	Level 5 (the highest possible)
ASTM F 1790-05	Level 4

Abrasion Resistance

EN 388:2003	Level 4 (the highest possible)
-------------	--------------------------------

Tear Resistance

EN 388:2003	Level 4 (the highest possible)
-------------	--------------------------------

Dimensional Stability Test	Achieved excellent results
----------------------------	----------------------------

CE Marking	Cat II PPE Directive
------------	----------------------

Sizes	S - 4XL
-------	---------

Clothing Care	Machine washable up to 40° Celsius
---------------	------------------------------------

Colour	Grey
--------	------

Place of Manufacture	EU
----------------------	----

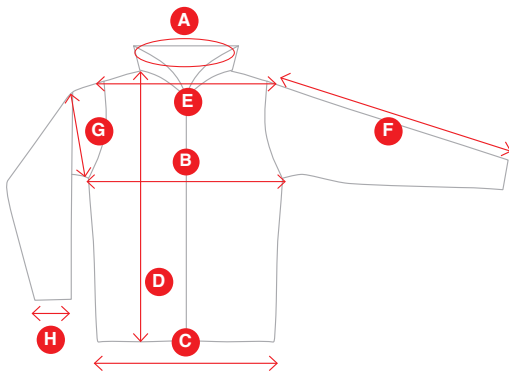

	Description	S	M	L	XL	2XL	3XL	4XL
A	Collar C	45.5	46.5	47.5	48.5	49.5	50.5	51.5
B	Chest	53	56	59	62	65	68	71
C	Hem	53	56	59	62	65	68	71
D	Front body length	69	72	75	78	81	84	87
E	Shoulder width	43	46	49	52	55	58	61
F	Sleeve overarm	60	62	64	66	67	68	68
G	Arm opening/hole	24	25	26	27	28	29	30
H	Sleeve cuff opening	10	10	11	11	12	13	14

All measurements are taken flat in centimetres, unless indicated with **C**. All measurements are approximate and offered as a guideline only. **C** = Circumference measurement.

Product: **SlashPRO™ Slash Resistant UBAC Shirt**

Model #: **100115**



SlashPRO™ Slash Resistant UBAC Shirts are manufactured using Cut-Tex® PRO - offering absolutely outstanding, tested and certified levels of cut, abrasion and tear resistance - providing an effective shield and protects areas often unguarded by common body armour e.g. key arteries from laceration and subsequent rapid blood loss.

Features & Benefits

- Offering comfortable yet effective cut protection to the radial artery, brachial artery, carotid artery and axillary artery whilst wearing body armour. Laceration of either of these arteries can lead to rapid blood loss and potential death.
- Two upper arm pockets (for small notepad and pens) with Velcro for rank patches, blood patches or other attachments
- Machine washable
- Thumb loops to keep sleeves in place
- 100% Latex free

Who Is This Product Suitable For?

Professionals working within these sectors:

- Law Enforcement
- Military
- Corrections / Prison Service
- Immigration
- Customs
- Border Control
- Private Security & Military Contractors
- Civil Enforcement

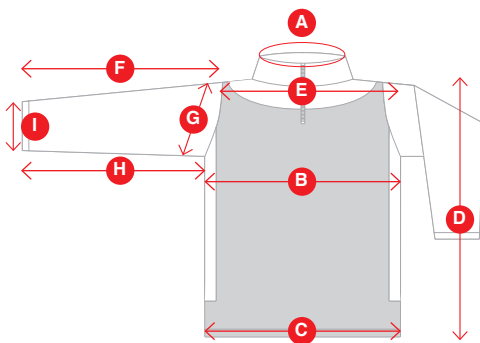

Material Content 100% Cut-Tex® PRO

Blade Cut Resistance

EN 388:2003 Level 5 (the highest possible)

ISO 13997:1999 Level 5 (the highest possible)

ASTM F 1790-05 Level 4

Abrasion Resistance

EN 388:2003 Level 4 (the highest possible)

Tear Resistance

EN 388:2003 Level 4 (the highest possible)

Dimensional Stability Test Achieved excellent results

CE Marking Cat II PPE Directive

Sizes S - 4XL

Clothing Care Machine washable up to 40° Celsius

Colour Grey

Place of Manufacture EU

	Description	S	M	L	XL	2XL	3XL	4XL
A	Collar C	44.5	45	45.5	46	46.5	47	48
B	Chest	51	54	57	60	63	66	69
C	Hem	51	54	57	60	63	66	69
D	Front Body †	69	72	75	78	81	84	87
E	Shoulder Width	43	46	49	52	55	58	61
F	Sleeve Overarm	61	62	63	64	65	66	67
G	Arm Opening/Hole	20	21	22	23	24	25	26
H	Under Arm Length	46.5	48	49.5	51	52.5	54	55.5
I	Sleeve Cuff Opening	11	12	13	14	15	16	16

All measurements are taken flat in centimetres, unless indicated with **C**. All measurements are approximate and offered as a guideline only. **C** = Circumference measurement. † = Length from neck point to hem.

Product: **SlashPRO™ Slash Resistant Hoodie with Kangaroo Front Pocket**

Model #: **100102**



SlashPRO™ Slash Resistant Hoodies are manufactured using Cut-Tex® PRO - offering absolutely outstanding, tested and certified levels of cut, abrasion and tear resistance.

Features & Benefits

- Cut-Tex® PRO used on the entire garment providing excellent cut and slash resistance
- 100% Latex free

Who Is This Product Suitable For?

Professionals working within these sectors:

- Law Enforcement
- Military
- Corrections / Prison Service
- Immigration
- Customs
- Border Control
- Private Security & Military Contractors
- Civil Enforcement

Material Content

100% Cut-Tex® PRO

Blade Cut Resistance

EN 388:2003 Level 5 (the highest possible)

ISO 13997:1999 Level 5 (the highest possible)

ASTM F 1790-05 Level 4

Abrasion Resistance

EN 388:2003 Level 4 (the highest possible)

Tear Resistance

EN 388:2003 Level 4 (the highest possible)

Dimensional Stability Test Achieved excellent results

CE Marking Cat II PPE Directive

Sizes S - 3XL

Clothing Care Machine washable up to 40° Celsius

Colour Grey

Place of Manufacture EU

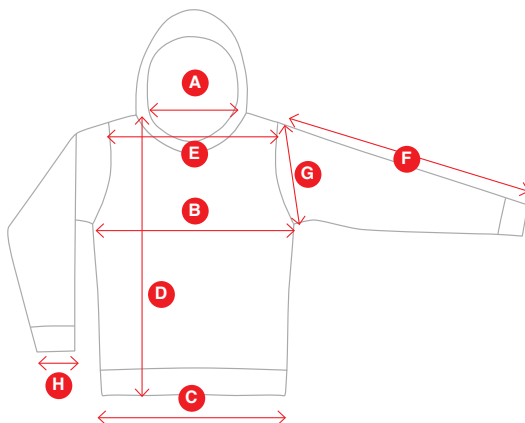

	Description	S	M	L	XL	2XL	3XL
A	Collar	15	16	17	18	19	20
B	Chest	50	52	54	56	60	64
C	Hem	51	53	55	57	61	65
D	Front body	64	66.5	69	71.5	74	76.5
E	Shoulder width	43	46	49	52	55	58
F	Sleeve overarm	61	62	63	64	65	66
G	Arm opening/hole	20	21	23	24	26	27
H	Sleeve cuff opening	8.5	9	9.5	10	10.5	11

All measurements are taken flat in centimetres. All measurements are approximate and offered as a guideline only.

Product: **SlashPRO™ Slash Resistant Turtleneck Sweatshirt with Thumbholes**

Model #: **100107**



SlashPRO™ Slash Resistant Sweatshirts are manufactured using Cut-Tex® PRO - offering absolutely outstanding, tested and certified levels of cut, abrasion and tear resistance.

Features & Benefits

- Cut-Tex® PRO used on the entire garment providing excellent cut and slash resistance
- High neck prevents neck and vertebral arteries from being exposed
- Thumbhole sleeves prevent the wrist and radial artery from being exposed
- 100% Latex free

Who Is This Product Suitable For?

Professionals working within these sectors:

- Law Enforcement
- Military
- Corrections / Prison Service
- Immigration
- Customs
- Border Control
- Private Security & Military Contractors
- Civil Enforcement

Material Content 100% Cut-Tex® PRO

Blade Cut Resistance

EN 388:2003 Level 5 (the highest possible)

ISO 13997:1999 Level 5 (the highest possible)

ASTM F 1790-05 Level 4

Abrasion Resistance

EN 388:2003 Level 4 (the highest possible)

Tear Resistance

EN 388:2003 Level 4 (the highest possible)

Dimensional Stability Test Achieved excellent results

CE Marking Cat II PPE Directive

Sizes S - 2XL

Clothing Care Machine washable up to 40° Celsius

Colour Grey

Place of Manufacture EU

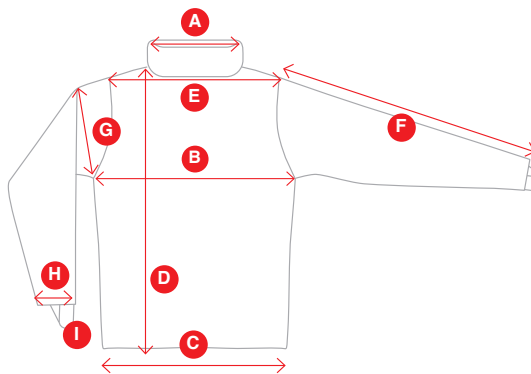

	Description	S	M	L	XL	2XL
A	Collar	18	19	20	21	22
B	Chest	50	52	54	56	60
C	Hem	50	52	54	56	60
D	Front body length	64	66.5	69	71.5	74
E	Shoulder width	43	46	49	52	55
F	Sleeve overarm	62	62	64	64	66
G	Arm opening/hole	20	21	23	24	26
H	Sleeve cuff opening	10	11	12	13	14
I	Thumbhole	5	5	5	5	5.5

All measurements are taken flat in centimetres. All measurements are approximate and offered as a guideline only.

Product: **SlashPRO™ Slash Resistant Neck Guard**

Model #: **100110**

SlashPRO™ Slash Resistant Neck Guards are manufactured using Cut-Tex® PRO which acts as an effective shield and protects areas often unguarded by common body armour.



Features & Benefits

- Offering comfortable yet effective cut protection to the carotid artery, an area even exposed whilst wearing any type of body armour. Laceration of this artery can lead to rapid blood loss and potential death.
- Folding down collar
- Machine washable
- 100% Latex free

Who Is This Product Suitable For?

Professionals working within these sectors:

- Law Enforcement
- Military
- Corrections / Prison Service
- Immigration
- Customs
- Border Control
- Private Security & Military Contractors
- Civil Enforcement

Find Your Size

Please use this chart as a guide. Measure the circumference of your head just above the brow line.

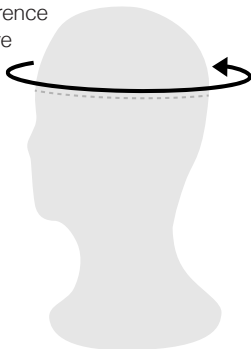

Size	Head circumference
S	50-52cm
M	53-55cm
L	56-58cm
XL	59-61cm
XXL	62-64cm

Material Content 100% Cut-Tex® PRO

Blade Cut Resistance

EN 388:2003	Level 5 (the highest possible)
ISO 13997:1999	Level 5 (the highest possible)
ASTM F 1790-05	Level 4

Abrasion Resistance

EN 388:2003	Level 4 (the highest possible)
-------------	--------------------------------

Tear Resistance

EN 388:2003	Level 4 (the highest possible)
-------------	--------------------------------

Dimensional Stability Test Achieved excellent results

CE Marking Cat II PPE Directive

Sizes S - 2XL

Clothing Care Machine washable up to 40° Celsius

Colour Black

Place of Manufacture EU

All measurements are taken flat in centimetres. All measurements are approximate and offered as a guideline only.
*Length from neck point to hem. **Fully open.

Size	A: Neck side point to point	B: Centre front length	C: Shoulder width
S	23cm	18cm	38cm
M	24cm	19cm	39cm
L	25cm	20cm	40cm
XL	26cm	21cm	41cm
XXL	27cm	22cm	42cm

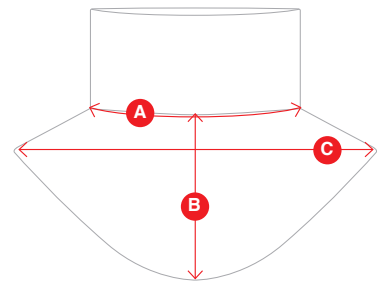

Product: **SlashPRO™ Slash Resistant Body Armour Base Layer**

Model #: **100112**



SlashPRO™ Slash Resistant Body Armour Base Layers are manufactured using Cut-Tex® PRO - offering absolutely outstanding, tested and certified levels of cut, abrasion and tear resistance.

Features & Benefits

- Cut-Tex® PRO used under the arm and the unprotected sides of the upper body - providing excellent cut and slash resistance
- 100% Latex free

Who Is This Product Suitable For?

Professionals working within these sectors:

- Law Enforcement
- Military
- Corrections / Prison Service
- Immigration
- Customs
- Border Control
- Private Security & Military Contractors
- Civil Enforcement

Material Content 100% Cut-Tex® PRO

Blade Cut Resistance

EN 388:2003 Level 5 (the highest possible)

ISO 13997:1999 Level 5 (the highest possible)

ASTM F 1790-05 Level 4

Abrasion Resistance

EN 388:2003 Level 4 (the highest possible)

Tear Resistance

EN 388:2003 Level 4 (the highest possible)

Dimensional Stability Test Achieved excellent results

CE Marking Cat II PPE Directive

Sizes S - 3XL

Clothing Care Machine washable up to 40° Celsius

Colour Grey

Place of Manufacture EU

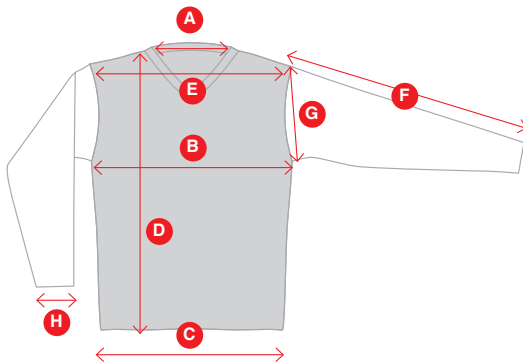

Description	S	M	L	XL	2XL	3XL
A Collar C	42.5	43	43.5	44	44.5	45
B Chest	51	54	57	60	63	66
C Hem	51	54	57	60	63	66
D Front body length	69	72	75	78	81	84
E Shoulder width	43	46	49	52	55	58
F Sleeve overarm	57	58	59	60	61	62
G Arm opening/hole	20	21	22	23	24	25
H Sleeve cuff opening	11	12	13	14	15	16

All measurements are taken flat in centimetres, unless indicated with **C**. All measurements are approximate and offered as a guideline only. **C** = Circumference measurement.

Product: **SlashPRO™ Slash Resistant Balaclava**

Model #: **100121**



SlashPRO™ Slash Resistant Balaclavas are manufactured using Cut-Tex® PRO - offering absolutely outstanding, tested and certified levels of cut, abrasion and tear resistance.

Features & Benefits

- Cut-Tex® PRO used on the entire garment providing excellent cut and slash resistance
- Ideal for forced entry operations and riot teams
- Effectively protecting Carotid Artery
- 100% Latex free

Who Is This Product Suitable For?

Professionals working within these sectors:

- Law Enforcement
- Military
- Corrections / Prison Service
- Immigration
- Customs
- Border Control
- Private Security & Military Contractors
- Civil Enforcement

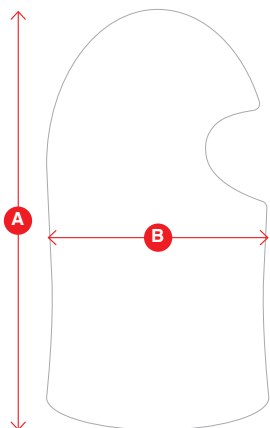

Material Content 100% Cut-Tex® PRO

Blade Cut Resistance

EN 388:2003 Level 5 (the highest possible)

ISO 13997:1999 Level 5 (the highest possible)

ASTM F 1790-05 Level 4

Abrasion Resistance

EN 388:2003 Level 4 (the highest possible)

Tear Resistance

EN 388:2003 Level 4 (the highest possible)

Dimensional Stability Test Achieved excellent results

CE Marking Cat II PPE Directive

Sizes S - 2XL

Clothing Care Machine washable up to 40° Celsius

Colour Grey

Place of Manufacture EU

	Description	S/M	L/XL	2XL/3XL
A	Height	43	45	47
B	Width	24	26	28

Product: **SlashPRO™ Slash Resistant Boxer Shorts**

Model #: **200150**

SlashPRO™ Slash Resistant Boxer Shorts are manufactured using Cut-Tex® PRO - offering absolutely outstanding, tested and certified levels of cut, abrasion and tear resistance.



Features & Benefits

- Excellent cut and slash protection
- 100% Latex free

Who Is This Product Suitable For?

Professionals working within these sectors:

- Law Enforcement
- Military
- Corrections / Prison Service
- Immigration
- Customs
- Border Control
- Private Security & Military Contractors
- Civil Enforcement

Material Content 100% Cut-Tex® PRO

Blade Cut Resistance

EN 388:2003 Level 5 (the highest possible)

ISO 13997:1999 Level 5 (the highest possible)

ASTM F 1790-05 Level 4

Abrasion Resistance

EN 388:2003 Level 4 (the highest possible)

Tear Resistance

EN 388:2003 Level 4 (the highest possible)

Dimensional Stability Test Achieved excellent results

CE Marking Cat II PPE Directive

Sizes S - 3XL

Clothing Care Machine washable up to 40° Celsius

Colour Grey

Place of Manufacture EU

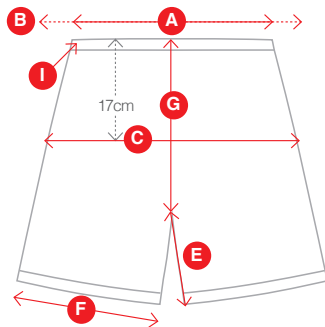

Description	S	M	L	XL	2XL	3XL
A Waist (relaxed)	30	34	38	42	46	50
B Waist (stretched)	45	49	53	57	61	65
C Hip - 17cm below waist	46	49	52	55	58	61
D Side leg length†	42	43	44	45	46	47
E Inside leg	20	20	20	20	20	20
F Leg opening	29	30	31	32	33	34
G Front rise†	28	29	30	31	32	33
H Back rise†	30	31	32	33	34	35
I Waist band depth	4	4	4	4	4	4

All measurements are taken flat in centimetres. All measurements are approximate and offered as a guideline only.
†Including waistband.

Product: **SlashPRO™ Slash Resistant Long Johns**

Model #: **200102**

SlashPRO™ Slash Resistant Long Johns are manufactured using Cut-TeX® PRO - offering absolutely outstanding, tested and certified levels of cut, abrasion and tear resistance.



Features & Benefits

- Excellent cut and slash protection for the lower part of the body
- Slim fit
- Adjustable cord
- 100% Latex free

Who Is This Product Suitable For?

Professionals working within these sectors:

- Law Enforcement
- Military
- Corrections / Prison Service
- Immigration
- Customs
- Border Control
- Private Security & Military Contractors
- Civil Enforcement

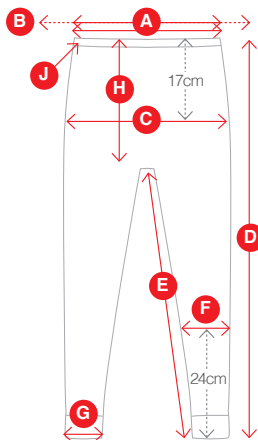

All measurements are taken flat in centimetres. All measurements are approximate and offered as a guideline only.
†Including waistband.

Material Content 100% Cut-TeX® PRO

Blade Cut Resistance

EN 388:2003 Level 5 (the highest possible)

ISO 13997:1999 Level 5 (the highest possible)

ASTM F 1790-05 Level 4

Abrasion Resistance

EN 388:2003 Level 4 (the highest possible)

Tear Resistance

EN 388:2003 Level 4 (the highest possible)

Dimensional Stability Test Achieved excellent results

CE Marking Cat II PPE Directive

Sizes S - 3XL

Clothing Care Machine washable up to 40° Celsius

Colour Grey

Place of Manufacture EU

Description	S	M	L	XL	2XL	3XL
A Waist (relaxed)	30	34	38	42	46	50
B Waist (stretched)	45	49	53	57	61	65
C Hip - 17cm below waist	46	49	52	55	58	61
D Outside leg length†	100.5	101	101.5	102	102.5	103
E Inside leg	76.5	77	77.5	78	78.5	79
F Calf width	22	22.5	23	23.5	24	24.5
G Ankle width	14	14	16	16	18	18
H Front rise†	28	29	30	31	32	33
I Back rise†	30	31	32	33	34	35
J Waist band depth	4	4	4	4	4	4

Product: **SlashPRO™ Slash Resistant Arm Guards V1**

Model #: **100500**

SlashPRO™ Arm Guards (Version 1) are manufactured using Cut-Tex® PRO - offering absolutely outstanding, tested and certified levels of cut, abrasion and tear resistance.



Features & Benefits

- Sold in pairs
- Overtly worn
- Excellent cut and slash resistance
- Thumbhole for improved fit
- Quick and easy to put on
- Highly breathable inner lining
- Durable and water repellent outer material
- 100% Latex free
- Also available as model with additional outstanding protection from severe bruising and blunt forced trauma - Model 100503

Who Is This Product Suitable For?

Professionals working within these sectors:

- Law Enforcement
- Military
- Corrections / Prison Service
- Immigration
- Customs
- Border Control
- Private Security & Military Contractors
- Civil Enforcement

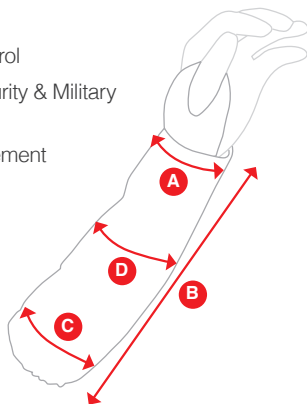

Blade Cut Resistance

EN 388:2003	Level 5 (the highest possible)
ISO 13997:1999	Level 5 (the highest possible)
ASTM F 1790-05	Level 4

Abrasion Resistance

EN 388:2003	Level 4 (the highest possible)
-------------	--------------------------------

Tear Resistance

EN 388:2003	Level 4 (the highest possible)
-------------	--------------------------------

Dimensional Stability Test	Achieved excellent results
----------------------------	----------------------------

CE Marking	Cat II PPE Directive
------------	----------------------

Sizes	S - XL
-------	--------

Clothing Care	Machine washable up to 40° Celsius
---------------	------------------------------------

Colour	Black
--------	-------

Place of Manufacture	EU
----------------------	----

	Description	S	M	L	XL
A	Cuff width	10	11	12	13
B	Sleeve length	23	26	29	29
C	Elasticated arm cuff (relaxed)	11	13	15	17
D	Arm width*	13	15	17	19

All measurements are taken flat in centimetres. All measurements are approximate and offered as a guideline only.
*Measured 14cm down from the elasticated cuff.

Product: **SlashPRO™ Slash Resistant Arm Guards V1 with Added Protection**

Model #: **100503**

SlashPRO™ Arm Guards are manufactured using Cut-Tex® PRO - offering absolutely outstanding, tested and certified levels of cut, abrasion and tear resistance.

This particular model provides **additional protection** to prevent severe bruising and blunt forced trauma - using specially engineered impact absorbing foam.



Features & Benefits

- Sold in pairs
- Overtly worn
- Excellent cut and slash resistance
- Worn tight around the forearm
- Thumbhole for improved fit
- Quick and easy to put on
- Highly breathable inner lining
- Durable and water repellent outer material
- 100% Latex free
- Additional protection to prevent severe bruising and blunt forced trauma

Who Is This Product Suitable For?

Professionals working within these sectors:

- Law Enforcement
- Military
- Corrections / Prison Service
- Immigration
- Customs
- Border Control
- Private Security & Military Contractors
- Civil Enforcement

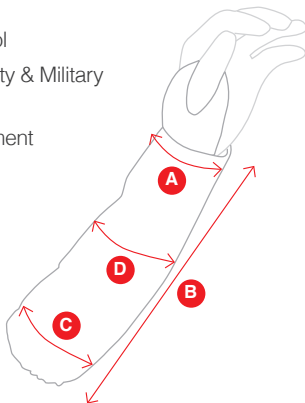

Blade Cut Resistance

EN 388:2003	Level 5 (the highest possible)
ISO 13997:1999	Level 5 (the highest possible)
ASTM F 1790-05	Level 4

Abrasion Resistance

EN 388:2003	Level 4 (the highest possible)
-------------	--------------------------------

Tear Resistance

EN 388:2003	Level 4 (the highest possible)
-------------	--------------------------------

Dimensional Stability Test	Achieved excellent results
----------------------------	----------------------------

CE Marking	Cat II PPE Directive
------------	----------------------

Sizes	S - XL
-------	--------

Clothing Care	Machine washable up to 40° Celsius
---------------	------------------------------------

Colour	Black
--------	-------

Place of Manufacture	EU
----------------------	----

Description	S	M	L	XL
A Cuff width	10	11.5	13	14.5
B Sleeve length	23	26	29	29
C Elasticated arm cuff (relaxed)	14	15	16	17
D Arm width*	14	16	18	20

All measurements are taken flat in centimetres. All measurements are approximate and offered as a guideline only.
*Measured 14cm down from the elasticated cuff.

Product: **SlashPRO™ Slash Resistant Arm Guards V2**

Model #: **100501**

SlashPRO™ Arm Guards (Version 2) are manufactured using Cut-Tex® PRO - offering absolutely outstanding, tested and certified levels of cut, abrasion and tear resistance.



Features & Benefits

- Sold in pairs
- Excellent cut and slash resistance
- Worn tight around the forearm
- 100% Latex free

Who Is This Product Suitable For?

Professionals working within these sectors:

- Law Enforcement
- Military
- Corrections / Prison Service
- Immigration
- Customs
- Border Control
- Private Security & Military Contractors
- Civil Enforcement

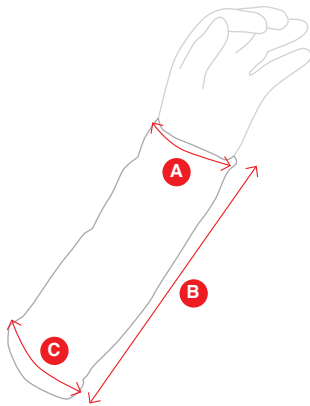

Blade Cut Resistance

EN 388:2003	Level 5 (the highest possible)
ISO 13997:1999	Level 5 (the highest possible)
ASTM F 1790-05	Level 4

Abrasion Resistance

EN 388:2003	Level 4 (the highest possible)
-------------	--------------------------------

Tear Resistance

EN 388:2003	Level 4 (the highest possible)
-------------	--------------------------------

Dimensional Stability Test	Achieved excellent results
----------------------------	----------------------------

CE Marking	Cat II PPE Directive
------------	----------------------

Sizes	S - XL
-------	--------

Clothing Care	Machine washable up to 40° Celsius
---------------	------------------------------------

Colour	Grey
--------	------

Place of Manufacture	EU
----------------------	----

Description	S	M	L	XL
A Cuff width	9	10	11	12
B Sleeve length	22	24	25	26
C Arm width	11	12	13	14

All measurements are taken flat in centimetres. All measurements are approximate and offered as a guideline only.

Product: **SlashPRO™ Slash Resistant Arm Guards V3**

Model #: **100504**

SlashPRO™ Arm Guards (Version 3) are manufactured using Cut-Tex® PRO - offering absolutely outstanding, tested and certified levels of cut, abrasion and tear resistance.



Features & Benefits

- Sold in pairs
- Excellent cut and slash resistance
- Worn tight around the forearm
- Also offering bite protection on inside and back of hand
- Thumbhole for improved fit
- 100% Latex free

Who Is This Product Suitable For?

Professionals working within these sectors:

- Law Enforcement
- Military
- Corrections / Prison Service
- Immigration
- Customs
- Border Control
- Private Security & Military Contractors
- Civil Enforcement

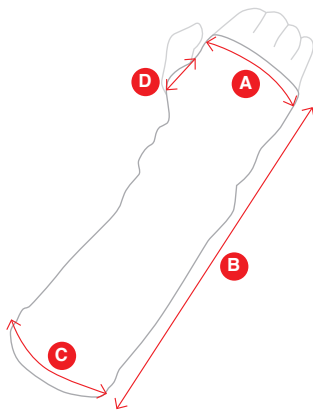

Blade Cut Resistance

EN 388:2003	Level 5 (the highest possible)
ISO 13997:1999	Level 5 (the highest possible)
ASTM F 1790-05	Level 4

Abrasion Resistance

EN 388:2003	Level 4 (the highest possible)
-------------	--------------------------------

Tear Resistance

EN 388:2003	Level 4 (the highest possible)
-------------	--------------------------------

Dimensional Stability Test	Achieved excellent results
----------------------------	----------------------------

CE Marking	Cat II PPE Directive
------------	----------------------

Sizes	S - 2XL
-------	---------

Clothing Care	Machine washable up to 40° Celsius
---------------	------------------------------------

Colour	Grey
--------	------

Place of Manufacture	EU
----------------------	----

	Description	S	M	L	XL
A	Cuff width	9	10	11	12
B	Sleeve length	30	32	33	34
C	Arm width	11	12	13	14
D	Thumbhole opening	6	6	6	6

All measurements are taken flat in centimetres. All measurements are approximate and offered as a guideline only.

Product: **SlashPRO™ Slash Resistant Full Arm Guards V4**

Model #: **100502**



SlashPRO™ Arm Guards (Version 4) are manufactured using Cut-Tex® PRO - offering absolutely outstanding, tested and certified levels of cut, abrasion and tear resistance.

Features & Benefits

- Sold as one unit
- Overtly worn
- Excellent cut and slash resistance
- Worn tight around the forearm
- Thumbhole for improved fit
- Quick and easy to put on
- Highly breathable inner lining
- Durable and water repellent outer material
- Thumb-loops to keep sleeves in perfect position even when arms are fully stretched or during high level of activity
- 100% Latex free

Who Is This Product Suitable For?

Professionals working within these sectors:

- Law Enforcement
- Military
- Corrections / Prison Service
- Immigration
- Customs
- Border Control
- Private Security & Military Contractors
- Civil Enforcement

Blade Cut Resistance

EN 388:2003	Level 5 (the highest possible)
ISO 13997:1999	Level 5 (the highest possible)
ASTM F 1790-05	Level 4

Abrasion Resistance

EN 388:2003	Level 4 (the highest possible)
-------------	--------------------------------

Tear Resistance

EN 388:2003	Level 4 (the highest possible)
-------------	--------------------------------

Dimensional Stability Test	Achieved excellent results
----------------------------	----------------------------

CE Marking	Cat II PPE Directive
------------	----------------------

Sizes	S - XL
-------	--------

Clothing Care	Machine washable up to 40° Celsius
---------------	------------------------------------

Colour	Black
--------	-------

Place of Manufacture	EU
----------------------	----

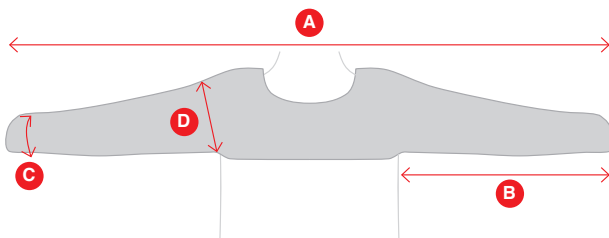

	Description	S	M	L	XL
A	Sleeve length	144	156	168	178
B	Sleeve under arm seam	48	50	55	60
C	Cuff opening	10	12	14	14
D	Arm hole opening	20	22	24	26

All measurements are taken flat in centimetres. All measurements are approximate and offered as a guideline only.



Product: **SlashPRO™ Slash Resistant Full Arm Guards V4 with Added Protection**

Model #: **100506**



SlashPRO™ Arm Guards (Version 4) are manufactured using Cut-Tex® PRO - offering absolutely outstanding, tested and certified levels of cut, abrasion and tear resistance.

This particular model provides **additional protection** to prevent severe bruising and blunt forced trauma - using specially engineered impact absorbing foam.

Features & Benefits

- Sold as one unit
- Overtly worn
- Excellent cut and slash resistance
- Worn tight around the forearm
- Thumbhole for improved fit
- Quick and easy to put on
- Highly breathable inner lining
- Durable and water repellent outer material
- Thumb-loops to keep sleeves in perfect position even when arms are fully stretched or during high level of activity
- 100% Latex free
- Additional protection to prevent severe bruising and blunt forced trauma

Who Is This Product Suitable For?

Professionals working within these sectors:

- Law Enforcement
- Military
- Corrections / Prison Service
- Immigration
- Customs
- Border Control
- Private Security & Military Contractors
- Civil Enforcement

Blade Cut Resistance

EN 388:2003	Level 5 (the highest possible)
ISO 13997:1999	Level 5 (the highest possible)
ASTM F 1790-05	Level 4

Abrasion Resistance

EN 388:2003	Level 4 (the highest possible)
-------------	--------------------------------

Tear Resistance

EN 388:2003	Level 4 (the highest possible)
-------------	--------------------------------

CE Marking Cat II PPE Directive

Sizes S - XL

Clothing Care Machine washable up to 40° Celsius

Colour Black

Place of Manufacture EU

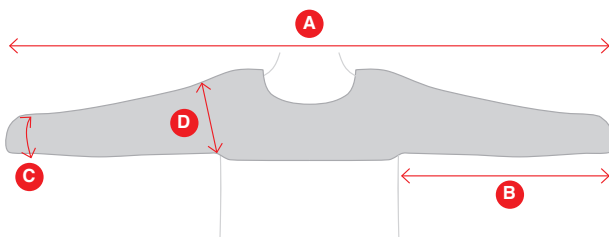

	Description	S	M	L	XL
A	Sleeve length	144	156	168	178
B	Sleeve under arm seam	48	50	55	60
C	Cuff opening	10	12	14	14
D	Arm hole opening	20	22	24	26



Visit our website: www.slash-pro.com

T: +44 (0) 845 5193 953 | E: info@slash-pro.com

Product: **SlashPRO™ Slash Resistant Arm Guards V5**

Model #: **100505**



SlashPRO™ Arm Guards (Version 5) are manufactured using Cut-Tex® PRO - offering absolutely outstanding, tested and certified levels of cut, abrasion and tear resistance.

Features & Benefits

- Sold as one unit
- Can be worn both overtly or covertly
- Excellent cut and slash resistance
- Worn tight around the forearm
- Also offering bite protection on inside and back of hand
- Thumbhole for improved fit
- 100% Latex free

Who Is This Product Suitable For?

Professionals working within these sectors:

- Law Enforcement
- Military
- Corrections / Prison Service
- Immigration
- Customs
- Border Control
- Private Security & Military Contractors
- Civil Enforcement

Blade Cut Resistance

EN 388:2003	Level 5 (the highest possible)
ISO 13997:1999	Level 5 (the highest possible)
ASTM F 1790-05	Level 4

Abrasion Resistance

EN 388:2003	Level 4 (the highest possible)
-------------	--------------------------------

Tear Resistance

EN 388:2003	Level 4 (the highest possible)
-------------	--------------------------------

Dimensional Stability Test	Achieved excellent results
----------------------------	----------------------------

CE Marking	Cat II PPE Directive
------------	----------------------

Sizes	S - XL
-------	--------

Clothing Care	Machine washable up to 40° Celsius
---------------	------------------------------------

Colour	Grey
--------	------

Place of Manufacture	EU
----------------------	----

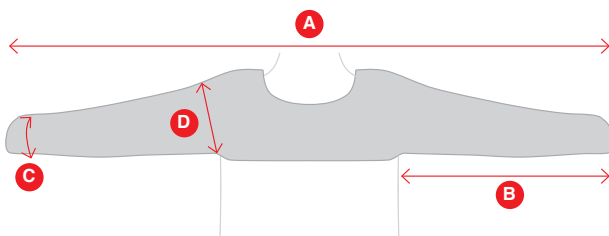

	Description	S	M	L	XL
A	Sleeve length	150	163	175	185
B	Sleeve under arm seam	50	53	58	63
C	Cuff opening	9	10	11	12
D	Arm hole opening	20	22	24	26

All measurements are taken flat in centimetres. All measurements are approximate and offered as a guideline only.



Product: **SlashPRO™ Slash Resistant Gloves - Ares**

Model #: **300102**



SlashPRO™ Gloves (Ares) are manufactured using Cut-Tex® PRO - offering absolutely outstanding, tested and certified levels of cut, abrasion and tear resistance.

For **additional needle protection** please [contact us](#)

Features & Benefits

- Cut-Tex® PRO provides excellent cut resistance to BS EN 388:2003 Level 5 (highest level possible)
- Lightweight nylon and elastane blend on the back of the hand
- Velcro strap keeps the gloves secure around the wrist
- Synthetic non-slip palm grip with reinforced palms and fingertips

Who Is This Product Suitable For?

Professionals working within these sectors:

- Law Enforcement
- Military
- Corrections / Prison Service
- Immigration
- Customs
- Border Control
- Private Security & Military Contractors
- Civil Enforcement

Blade Cut Resistance

EN 388:2003	Level 5 (the highest possible)
ISO 13997:1999	Level 5 (the highest possible)
ASTM F 1790-05	Level 4

Abrasion Resistance

EN 388:2003	Level 4 (the highest possible)
-------------	--------------------------------

Tear Resistance

EN 388:2003	Level 4 (the highest possible)
-------------	--------------------------------

Dimensional Stability Test	Achieved excellent results
----------------------------	----------------------------

CE Marking	Cat II PPE Directive
------------	----------------------

Sizes	S - 2XL
-------	---------

Clothing Care	Machine washable up to 40° Celsius
---------------	------------------------------------

Colour	Grey
--------	------

1. Find Your Hand Width

Wrap a tailor's measuring tape around your dominant hand just below the knuckles, excluding your thumb, and make a fist. This is your 'hand width'.

EU Glove size	US Glove size	Inches	CMs
6	XS	6-7	15-17
7	S	7-8	17-20
8	M	8-9	20-22
9	L	9-10	22-25
10	XL	10-11	25-27
11	2XL	11+	28+

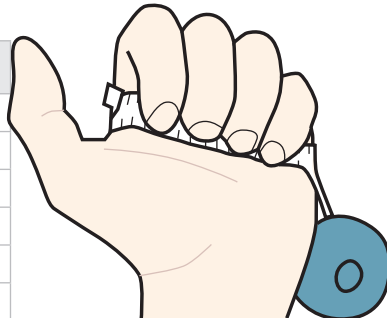

2. Find Your Hand Length

Measure from the bottom edge of your palm to the tip of your middle finger to find your 'finger length'.

EU Glove size	US Glove size	Inches	CMs
6	XS	6.5	16.5
7	S	7	18
8	M	7.5	19
9	L	8	20
10	XL	8.5	21.5
11	2XL	9	23

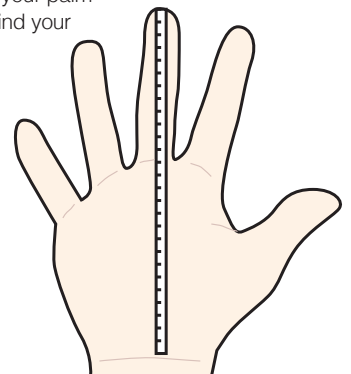

Visit our website: www.slash-pro.com

T: +44 (0) 845 5193 953 | E: info@slash-pro.com



Product: **SlashPRO™ Slash Resistant Gloves - Ares Long**

Model #: **300109**

SlashPRO™ Gloves (Ares Long) are manufactured using Cut-Tex® PRO - offering absolutely outstanding, tested and certified levels of cut, abrasion and tear resistance.



For **additional needle protection** please [contact us](#)

Features & Benefits

- Cut-Tex® PRO provides excellent cut resistance to BS EN 388:2003 Level 5 (highest level possible)
- Lightweight nylon and elastane blend on the back of the hand
- Velcro strap keeps the gloves secure around the wrist
- Synthetic non-slip palm grip with reinforced palms and fingertips

Who Is This Product Suitable For?

Professionals working within these sectors:

- Law Enforcement
- Military
- Corrections / Prison Service
- Immigration
- Customs
- Border Control
- Private Security & Military Contractors
- Civil Enforcement

Blade Cut Resistance

EN 388:2003	Level 5 (the highest possible)
ISO 13997:1999	Level 5 (the highest possible)
ASTM F 1790-05	Level 4

Abrasion Resistance

EN 388:2003	Level 4 (the highest possible)
-------------	--------------------------------

Tear Resistance

EN 388:2003	Level 4 (the highest possible)
-------------	--------------------------------

Dimensional Stability Test	Achieved excellent results
----------------------------	----------------------------

CE Marking	Cat II PPE Directive
------------	----------------------

Sizes	S - 2XL
-------	---------

Clothing Care	Machine washable up to 40° Celsius
---------------	------------------------------------

Colour	Grey
--------	------

1. Find Your Hand Width

Wrap a tailor's measuring tape around your dominant hand just below the knuckles, excluding your thumb, and make a fist. This is your 'hand width'.

EU Glove size	US Glove size	Inches	CMs
6	XS	6-7	15-17
7	S	7-8	17-20
8	M	8-9	20-22
9	L	9-10	22-25
10	XL	10-11	25-27
11	2XL	11+	28+

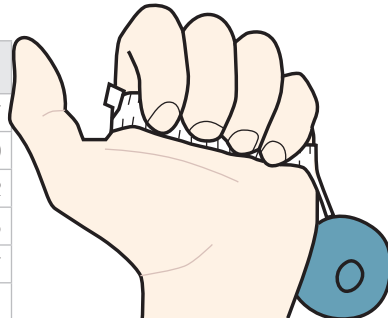

2. Find Your Hand Length

Measure from the bottom edge of your palm to the tip of your middle finger to find your 'finger length'.

EU Glove size	US Glove size	Inches	CMs
6	XS	6.5	16.5
7	S	7	18
8	M	7.5	19
9	L	8	20
10	XL	8.5	21.5
11	2XL	9	23

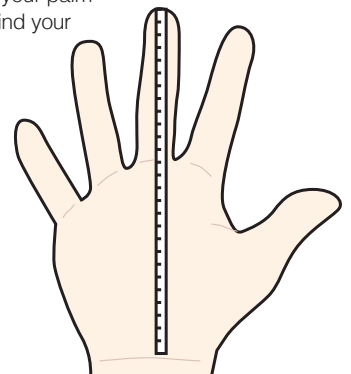

Visit our website: www.slash-pro.com

T: +44 (0) 845 5193 953 | E: info@slash-pro.com



Product: **SlashPRO™ Slash Resistant Gloves - Hera**

Model #: **300110**



SlashPRO™ Gloves (Hera) are manufactured using Cut-Tex® PRO - offering absolutely outstanding, tested and certified levels of cut, abrasion and tear resistance.

For **additional needle protection** please [contact us](#)

Features & Benefits

- Cut-Tex® PRO provides excellent cut resistance to BS EN 388:2003 Level 5 (highest level possible)
- Lightweight nylon and elastane blend on the back of the hand
- Elasticised wrist keeps the gloves secure around the wrist

Who Is This Product Suitable For?

Professionals working within these sectors:

- Law Enforcement
- Military
- Corrections / Prison Service
- Immigration
- Customs
- Border Control
- Private Security & Military Contractors
- Civil Enforcement

Blade Cut Resistance

EN 388:2003	Level 5 (the highest possible)
ISO 13997:1999	Level 5 (the highest possible)
ASTM F 1790-05	Level 4

Abrasion Resistance

EN 388:2003	Level 4 (the highest possible)
-------------	--------------------------------

Tear Resistance

EN 388:2003	Level 4 (the highest possible)
-------------	--------------------------------

Dimensional Stability Test	Achieved excellent results
----------------------------	----------------------------

CE Marking	Cat II PPE Directive
------------	----------------------

Sizes	S - 2XL
-------	---------

Clothing Care	Machine washable up to 40° Celsius
---------------	------------------------------------

Colour	Grey
--------	------

1. Find Your Hand Width

Wrap a tailor's measuring tape around your dominant hand just below the knuckles, excluding your thumb, and make a fist. This is your 'hand width'.

EU Glove size	US Glove size	Inches	CMs
6	XS	6-7	15-17
7	S	7-8	17-20
8	M	8-9	20-22
9	L	9-10	22-25
10	XL	10-11	25-27
11	2XL	11+	28+

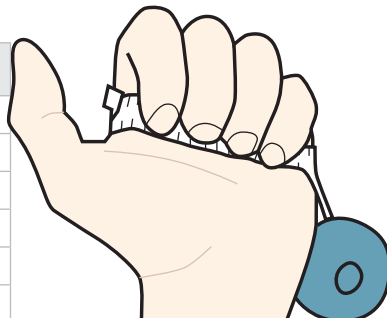

2. Find Your Hand Length

Measure from the bottom edge of your palm to the tip of your middle finger to find your 'finger length'.

EU Glove size	US Glove size	Inches	CMs
6	XS	6.5	16.5
7	S	7	18
8	M	7.5	19
9	L	8	20
10	XL	8.5	21.5
11	2XL	9	23

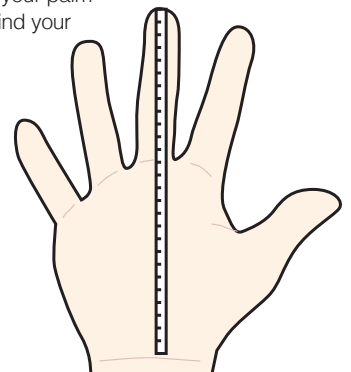

Visit our website: www.slash-pro.com

T: +44 (0) 845 5193 953 | E: info@slash-pro.com



Product: **SlashPRO™ Slash Resistant Gloves - Heracles**

Model #: **300106**



SlashPRO™ Gloves (Heracles) are manufactured using Cut-Tex® PRO - offering absolutely outstanding, tested and certified levels of cut, abrasion and tear resistance.

For **additional needle protection** please [contact us](#)

Features & Benefits

- Cut-Tex® PRO provides excellent cut resistance to BS EN 388:2003 Level 5 (highest level possible)
- Kevlar® outer with leather palms - sewn with abrasion, cut and heat resistant Kevlar® thread
- Velcro strap keeps the gloves secure around the wrist
- Soft padded knuckle protection
- Synthetic non-slip palm grip with reinforced palms and fingertips

Who Is This Product Suitable For?

Professionals working within these sectors:

- Law Enforcement
- Military
- Corrections / Prison Service
- Immigration
- Customs
- Border Control
- Private Security & Military Contractors
- Civil Enforcement

Blade Cut Resistance

EN 388:2003	Level 5 (the highest possible)
ISO 13997:1999	Level 5 (the highest possible)
ASTM F 1790-05	Level 4

Abrasion Resistance

EN 388:2003	Level 4 (the highest possible)
-------------	--------------------------------

Tear Resistance

EN 388:2003	Level 4 (the highest possible)
-------------	--------------------------------

Dimensional Stability Test	Achieved excellent results
----------------------------	----------------------------

CE Marking	Cat II PPE Directive
------------	----------------------

Sizes	S - 2XL
-------	---------

Clothing Care	Machine washable up to 40° Celsius
---------------	------------------------------------

Colour	Grey
--------	------

1. Find Your Hand Width

Wrap a tailor's measuring tape around your dominant hand just below the knuckles, excluding your thumb, and make a fist. This is your 'hand width'.

EU Glove size	US Glove size	Inches	CMs
6	XS	6-7	15-17
7	S	7-8	17-20
8	M	8-9	20-22
9	L	9-10	22-25
10	XL	10-11	25-27
11	2XL	11+	28+

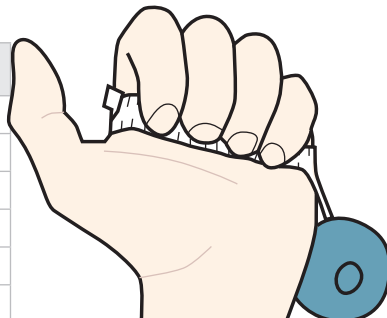

2. Find Your Hand Length

Measure from the bottom edge of your palm to the tip of your middle finger to find your 'finger length'.

EU Glove size	US Glove size	Inches	CMs
6	XS	6.5	16.5
7	S	7	18
8	M	7.5	19
9	L	8	20
10	XL	8.5	21.5
11	2XL	9	23

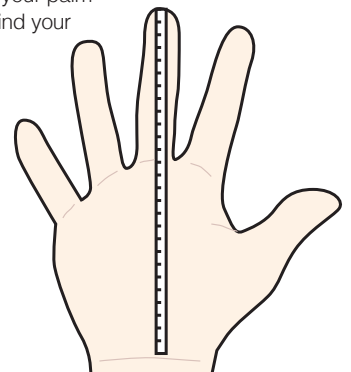

Visit our website: www.slash-pro.com

T: +44 (0) 845 5193 953 | E: info@slash-pro.com



Product: **SlashPRO™ Slash Resistant Gloves - Titan**

Model #: **300116**

SlashPRO™ Gloves (Titan) are manufactured using Cut-Tex® PRO - offering absolutely outstanding, tested and certified levels of cut, abrasion and tear resistance.

For **additional needle protection** please [contact us](#)

Features & Benefits

- Cut-Tex® PRO provides excellent cut resistance to BS EN 388:2003 Level 5 (highest level possible)
- 100% Cow hide leather palm
- Carbon knuckle protection with ventilation on the fingers
- Synthetic non-slip back and palm grip
- Soft padded cuff with Velcro strap to secure around wrist

Who Is This Product Suitable For?

Professionals working within these sectors:

- Law Enforcement
- Military
- Corrections / Prison Service
- Immigration
- Customs
- Border Control
- Private Security & Military Contractors
- Civil Enforcement

Blade Cut Resistance

EN 388:2003	Level 5 (the highest possible)
ISO 13997:1999	Level 5 (the highest possible)
ASTM F 1790-05	Level 4

Abrasion Resistance

EN 388:2003	Level 4 (the highest possible)
-------------	--------------------------------

Tear Resistance

EN 388:2003	Level 4 (the highest possible)
-------------	--------------------------------

Dimensional Stability Test	Achieved excellent results
----------------------------	----------------------------

CE Marking	Cat II PPE Directive
------------	----------------------

Sizes	S - 2XL
-------	---------

Clothing Care	Machine washable up to 40° Celsius
---------------	------------------------------------

Colour	Grey
--------	------

1. Find Your Hand Width

Wrap a tailor's measuring tape around your dominant hand just below the knuckles, excluding your thumb, and make a fist. This is your 'hand width'.

EU Glove size	US Glove size	Inches	CMs
6	XS	6-7	15-17
7	S	7-8	17-20
8	M	8-9	20-22
9	L	9-10	22-25
10	XL	10-11	25-27
11	2XL	11+	28+

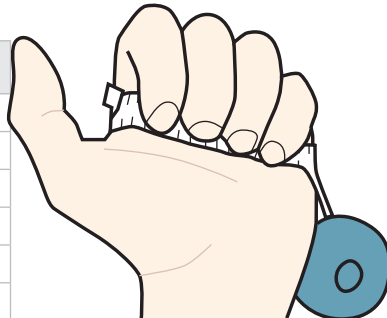

2. Find Your Hand Length

Measure from the bottom edge of your palm to the tip of your middle finger to find your 'finger length'.

EU Glove size	US Glove size	Inches	CMs
6	XS	6.5	16.5
7	S	7	18
8	M	7.5	19
9	L	8	20
10	XL	8.5	21.5
11	2XL	9	23

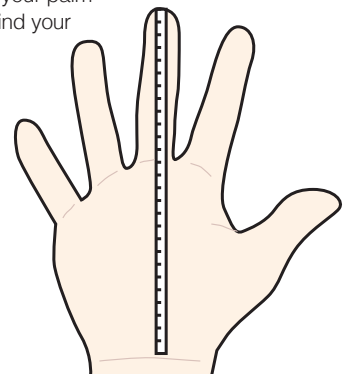

Visit our website: www.slash-pro.com

T: +44 (0) 845 5193 953 | E: info@slash-pro.com



Product: **SlashPRO™ Slash Resistant Gloves - Classic**

Model #: **300104**



SlashPRO™ Gloves (Classic) are manufactured using Cut-Tex® PRO - offering absolutely outstanding, tested and certified levels of cut, abrasion and tear resistance.

For **additional needle protection** please [contact us](#)

Features & Benefits

- Cut-Tex® PRO provides excellent cut resistance to BS EN 388:2003 Level 5 (highest level possible)
- 100% Cow hide leather outer shell
- Elasticised wrist keeps the gloves secure around the wrist

Who Is This Product Suitable For?

Professionals working within these sectors:

- Law Enforcement
- Military
- Corrections / Prison Service
- Immigration
- Customs
- Border Control
- Private Security & Military Contractors
- Civil Enforcement

Blade Cut Resistance

EN 388:2003	Level 5 (the highest possible)
ISO 13997:1999	Level 5 (the highest possible)
ASTM F 1790-05	Level 4

Abrasion Resistance

EN 388:2003	Level 4 (the highest possible)
-------------	--------------------------------

Tear Resistance

EN 388:2003	Level 4 (the highest possible)
-------------	--------------------------------

Dimensional Stability Test Achieved excellent results

CE Marking Cat II PPE Directive

Sizes S - 2XL

Clothing Care Machine washable up to 40° Celsius

Colour Grey

1. Find Your Hand Width

Wrap a tailor's measuring tape around your dominant hand just below the knuckles, excluding your thumb, and make a fist. This is your 'hand width'.

EU Glove size	US Glove size	Inches	CMs
6	XS	6-7	15-17
7	S	7-8	17-20
8	M	8-9	20-22
9	L	9-10	22-25
10	XL	10-11	25-27
11	2XL	11+	28+

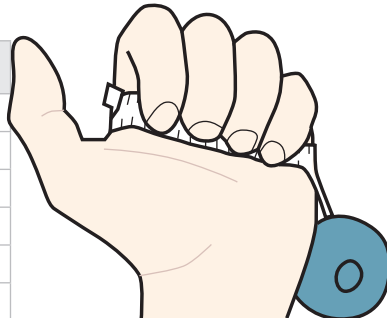

2. Find Your Hand Length

Measure from the bottom edge of your palm to the tip of your middle finger to find your 'finger length'.

EU Glove size	US Glove size	Inches	CMs
6	XS	6.5	16.5
7	S	7	18
8	M	7.5	19
9	L	8	20
10	XL	8.5	21.5
11	2XL	9	23

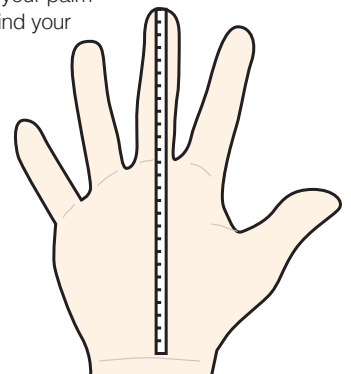

Visit our website: www.slash-pro.com

T: +44 (0) 845 5193 953 | E: info@slash-pro.com



Product: **SlashPRO™ Slash Resistant Gloves - Nemesis**

Model #: **300111**

SlashPRO™ Gloves (Nemesis) are manufactured using Cut-Tex® PRO - offering absolutely outstanding, tested and certified levels of cut, abrasion and tear resistance.



For **additional needle protection** please [contact us](#)

Features & Benefits

- Cut-Tex® PRO provides excellent cut resistance to BS EN 388:2003 Level 5 (highest level possible)
- Nomex® Fire Resistant Outer
- Elasticised wrist with extended arm for protection of the Radial artery
- Silicone dotted palm and fingers
- Leather padded knuckle protection

Who Is This Product Suitable For?

Professionals working within these sectors:

- Law Enforcement
- Military
- Corrections / Prison Service
- Immigration
- Customs
- Border Control
- Private Security & Military Contractors
- Civil Enforcement

Blade Cut Resistance

EN 388:2003	Level 5 (the highest possible)
ISO 13997:1999	Level 5 (the highest possible)
ASTM F 1790-05	Level 4

Abrasion Resistance

EN 388:2003	Level 4 (the highest possible)
-------------	--------------------------------

Tear Resistance

EN 388:2003	Level 4 (the highest possible)
-------------	--------------------------------

Dimensional Stability Test	Achieved excellent results
----------------------------	----------------------------

CE Marking	Cat II PPE Directive
------------	----------------------

Sizes	S - 2XL
-------	---------

Clothing Care	Machine washable up to 40° Celsius
---------------	------------------------------------

Colour	Grey
--------	------

1. Find Your Hand Width

Wrap a tailor's measuring tape around your dominant hand just below the knuckles, excluding your thumb, and make a fist. This is your 'hand width'.

EU Glove size	US Glove size	Inches	CMs
6	XS	6-7	15-17
7	S	7-8	17-20
8	M	8-9	20-22
9	L	9-10	22-25
10	XL	10-11	25-27
11	2XL	11+	28+

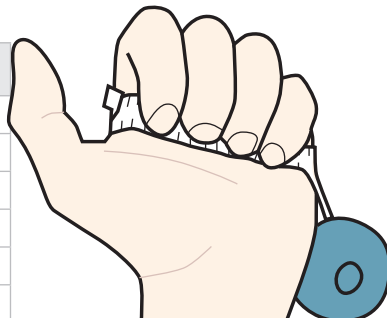

2. Find Your Hand Length

Measure from the bottom edge of your palm to the tip of your middle finger to find your 'finger length'.

EU Glove size	US Glove size	Inches	CMs
6	XS	6.5	16.5
7	S	7	18
8	M	7.5	19
9	L	8	20
10	XL	8.5	21.5
11	2XL	9	23

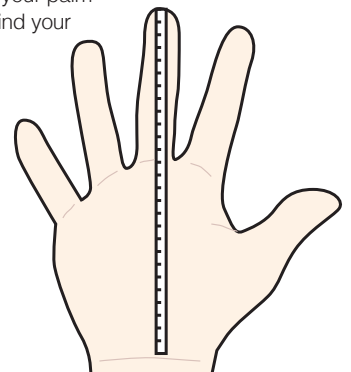

Visit our website: www.slash-pro.com

T: +44 (0) 845 5193 953 | E: info@slash-pro.com

Contact

PPSS Group

Whitfield Business Park
Unit 1-2, Manse Lane
Knaresborough
HG5 8BS
United Kingdom

T: **+44 (0) 845 5193 953**

E: **info@ppss-group.com**

W: **www.ppss-group.com**



Visit our website: www.slash-pro.com

T: +44 (0) 845 5193 953 | E: info@slash-pro.com