

BitePRO® BITE RESISTANT CLOTHING CATALOGUE 2017



Contents

2. Introduction – BitePRO® Arm Guards & Clothing

3. About Cut-TEX® PRO

PRODUCTS

GRAB BAG

4. BitePRO® Grab Bag

ARM GUARDS

5. BitePRO® Bite Resistant Arm Guards V1

6. BitePRO® Bite Resistant Arm Guards V1 with Added Protection

7. BitePRO® Bite Resistant Arm Guards V2

8. BitePRO® Bite Resistant Arm Guards V3

9. BitePRO® Bite Resistant Full Arm Guards V4

10. BitePRO® Bite Resistant Full Arm Guards V4 with Added Protection

11. BitePRO® Bite Resistant Arm Guards V5

12. BitePRO® Bite Resistant Arm Guard Shirt

UPPER BODY

13. BitePRO® Bite Resistant Turtleneck Jacket

14. BitePRO® Bite Resistant Hoodie

15. BitePRO® Bite Resistant Sweatshirt (Long Sleeve)

16. BitePRO® Bite Resistant T-Shirt

17. BitePRO® Bite Resistant Polo Sweatshirt (Long Sleeve)

18. BitePRO® Bite Resistant Polo T-Shirt

19. BitePRO® 3MM Front Only Body Armour

LOWER BODY

20. BitePRO® Bite Resistant Boxer Shorts

21. BitePRO® Bite Resistant Long Johns

22. BitePRO® Bite Resistant Leg Guards

GLOVES

23. BitePRO® Bite Resistant Gloves - Short

24. BitePRO® Bite Resistant Gloves - Long

25. BitePRO® Bite Resistant Gloves - Fingerless

26. Contact

FOR ORDERS OF 1-5, PLEASE BUY ONLINE:

Visit our website: www.bite-pro.com

T: +44 (0) 845 5193 953 | E: info@bite-pro.com



BitePRO® Arm Guards & Clothing

The risk of being bitten by a human is a reality for professionals working in specialist schools for severe learning disabilities, challenging behaviour, special needs or autism – as well as care workers within mental health care facilities and psychiatric hospitals.

BitePRO® Arm Guards & Clothing can effectively help reduce the risk of such injuries, offering BS EN 388:2003 blade cut resistance level 5 and extremely high puncture resistance to human teeth.

Bite related injuries can of course become infected and mental health care professionals could subsequently be contaminated with pathogens. Transmissions of potentially life threatening viruses, such as Hepatitis B, Hepatitis C or HIV are also a part of reality.

Please note this type of bite resistant clothing reduces the risk of human teeth penetrating the other person's skin, but does not stop the potentially painful effect due to the pressure and force being used. So the risk of infection will be eliminated but the risk of bruising remains.

However, our Version 1 sleeves (arm guards) are also available with additional protection. This particular model will substantially reduce the pain created by pressure and force and risk of bruising.

“ Bites can cause both physical injury, risk of infection, soft tissue damage and psychological distress to staff. Whilst our staff teams are usually aware of the potential for bites from records of previous incidents and preventative steps are taken, additional measures to protect staff from a bite may be beneficial.”

Says Debbie Townsend, Physical Intervention Training Manager of the Oxfordshire Learning Disability NHS Trust (UK)

Why Bite Resistant Arm Guards & Clothing Are So Important?

- A skin break increases the risk of infection and makes it necessary to be sure tetanus shots are up-to-date.
- A skin break is often obvious but can be tough to tell in some cases. Anything that looks like the top layer of skin has come off should be considered a skin break.
- Wound infection occurs in 9-50% of human bites.
- Risk of severe infection is particularly high in bite injuries.
- The average human bite pressure is in the range of 2840 to 4270 psi.
- The human bite forces range from 55 lbs to 280 lbs... averaging 162 lbs.



BitePRO® Arm Guard Version 1

FOR ORDERS OF 1-5, PLEASE BUY ONLINE:

Visit our website: www.bite-pro.com

T: +44 (0) 845 5193 953 | E: info@bite-pro.com



About Cut-Tex[®] PRO



Cut-Tex[®] PRO is an ultra-high performance cut, bite and slash resistant fabric, comfortable to wear, fully machine washable and of truly exceptional strength and durability - making it the ideal material for BitePRO[®] Arm Guards.

As you can see below, Cut-Tex[®] PRO performs very highly in all cut, tear and abrasion tests:

Cut-Tex[®] PRO Performance Charts:

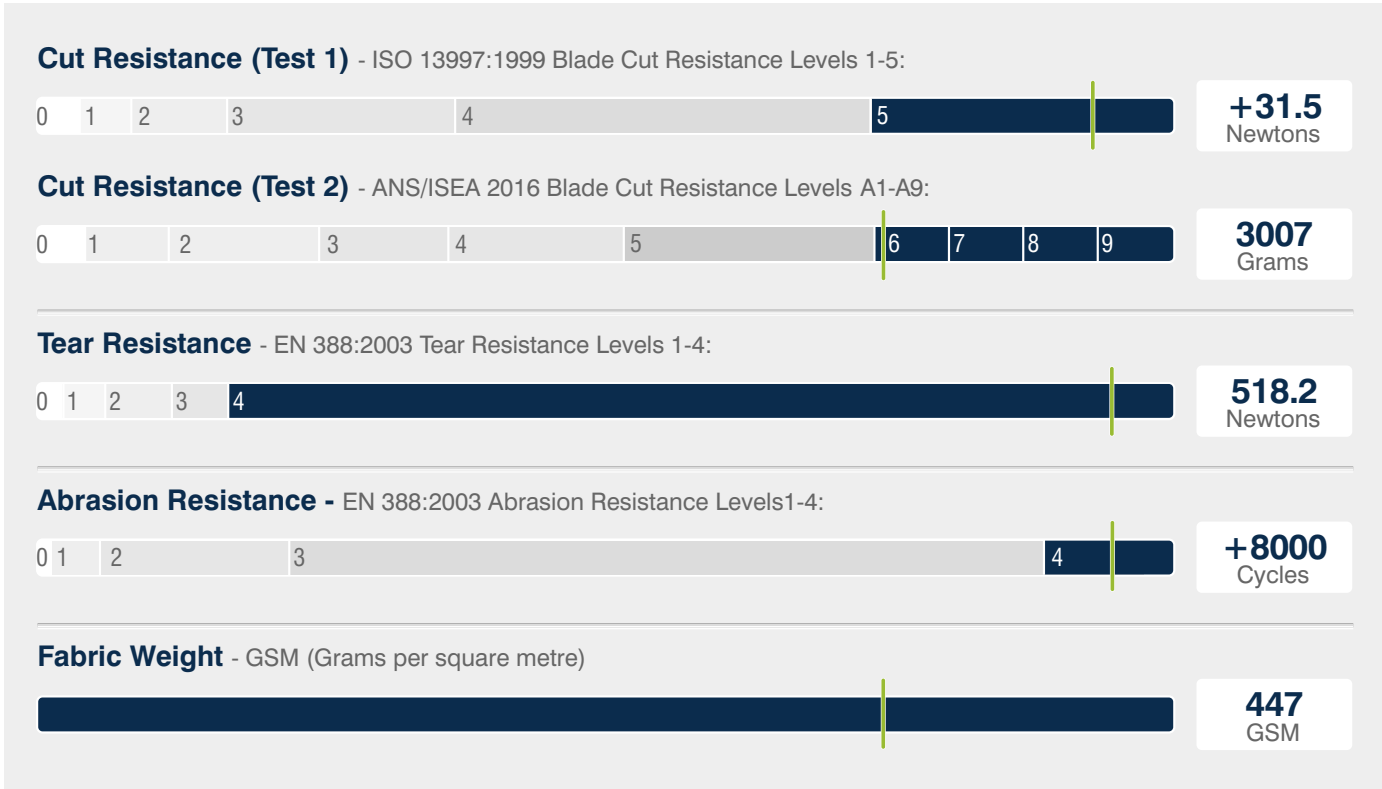

FOR ORDERS OF 1-5, PLEASE BUY ONLINE:

Visit our website: www.bite-pro.com

T: +44 (0) 845 5193 953 | E: info@bite-pro.com



Product: **BitePRO® Grab Bag**

Model #: **100600**

The BitePRO® Grab Bag can be placed in an office of any mental health care facility, special educational needs school or care home.

Staff can quickly choose from a range of bite resistant garments based on their requirements.



Features & Benefits

- Users can quickly choose an appropriate garment to deal with a particular incident or patient
- Wide range of garment sizes available
- Cost-effective for health care facilities with a frequent turnaround of operational staff

Here's What's Included In The BitePRO® Grab Bag:

- 4 x Version 1 Arm Guards (S-XL)
- 4 x Version 3 Arm Guards (S-XL)
- 4 x Version 4 Arm Guards (S-XL)
- 4 x Turtleneck Jacket (S-XL)

Who Is This Product Suitable For?

Professionals working within these sectors:

- Mental Health Care
- Special Needs
- Special Education
- Challenging Behaviour
- Learning Disabilities
- Autism

Blade Cut Resistance

EN 388:2003	Level 5 (the highest possible)
ISO 13997:1999	Level 5 (the highest possible)
ASTM F 1790-05	Level 4

Abrasion Resistance

EN 388:2003	Level 4 (the highest possible)
-------------	--------------------------------

Tear Resistance

EN 388:2003	Level 4 (the highest possible)
-------------	--------------------------------

Dimensional Stability Test	Achieved excellent results
----------------------------	----------------------------

CE Marking	Cat II PPE Directive
------------	----------------------

Sizes

Arm Guards	S - XL
------------	--------

Turtleneck Jacket	S - XL
-------------------	--------



BitePRO® Version 1 Arm Guards



BitePRO® Version 3 Arm Guards



BitePRO® Version 4 Arm Guards



BitePRO® Turtleneck Jacket

FOR ORDERS OF 1-5, PLEASE BUY ONLINE:

Visit our website: www.bite-pro.com

T: +44 (0) 845 5193 953 | E: info@bite-pro.com



Product: **BitePRO® Bite Resistant Arm Guards V1**

Model #: **100500**

BitePRO® Arm Guards (Version 1) are manufactured using Cut-Tex® PRO, our ground-breaking bite resistant material that prevents human teeth from penetrating the wearer's skin.

Available in  Black  Grey  Royal Blue



Features & Benefits

- Sold in pairs
- Overtly worn
- Excellent bite resistance
- Thumbhole for improved fit
- Quick and easy to put on
- Highly breathable inner lining
- Durable and water repellent outer material
- 100% Latex free
- Also available as model with additional outstanding protection from severe bruising and blunt forced trauma - Model 100503

Who Is This Product Suitable For?

Professionals working within these sectors:

- Mental Health Care
- Special Needs
- Special Education
- Challenging Behaviour
- Learning Disabilities
- Autism

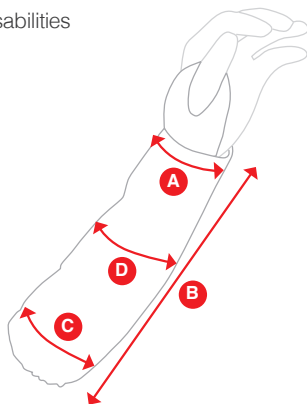

Blade Cut Resistance

EN 388:2003	Level 5 (the highest possible)
ISO 13997:1999	Level 5 (the highest possible)
ASTM F 1790-05	Level 4

Abrasion Resistance

EN 388:2003	Level 4 (the highest possible)
-------------	--------------------------------

Tear Resistance

EN 388:2003	Level 4 (the highest possible)
-------------	--------------------------------

Dimensional Stability Test	Achieved excellent results
----------------------------	----------------------------

CE Marking	Cat II PPE Directive
------------	----------------------

Sizes	S - XL
-------	--------

Clothing Care	Machine washable up to 40° Celsius
---------------	------------------------------------

Colour	Choice of Black, Grey or Royal Blue
--------	-------------------------------------

Place of Manufacture	EU
----------------------	----

Description	S	M	L	XL
A Cuff width	10	11	12	13
B Sleeve length	23	26	29	29
C Elasticated arm cuff (relaxed)	11	13	15	17
D Arm width*	13	15	17	19

All measurements are taken flat in centimetres. All measurements are approximate and offered as a guideline only.
*Measured 14cm down from the elasticated cuff.



FOR ORDERS OF 1-5, PLEASE BUY ONLINE:

Visit our website: www.bite-pro.com

T: +44 (0) 845 5193 953 | E: info@bite-pro.com



Product: **BitePRO® Bite Resistant Arm Guards V1 with Added Protection**

Model #: **100503**

BitePRO® Arm Guards are manufactured using Cut-Tex® PRO, our ground-breaking bite resistant material that prevents human teeth from penetrating the wearer's skin.

This particular model provides **additional protection** to prevent severe bruising and blunt forced trauma - using specially engineered impact absorbing foam.



Features & Benefits

- Sold in pairs
- Overtly worn
- Excellent bite resistance
- Worn tight around the forearm
- Thumbhole for improved fit
- Quick and easy to put on
- Highly breathable inner lining
- Durable and water repellent outer material
- 100% Latex free
- Additional protection to prevent severe bruising and blunt forced trauma

Who Is This Product Suitable For?

Professionals working within these sectors:

- Mental Health Care
- Special Needs
- Special Education
- Challenging Behaviour
- Learning Disabilities
- Autism

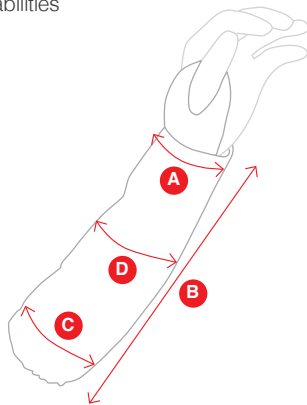

Blade Cut Resistance

EN 388:2003	Level 5 (the highest possible)
ISO 13997:1999	Level 5 (the highest possible)
ASTM F 1790-05	Level 4

Abrasion Resistance

EN 388:2003	Level 4 (the highest possible)
-------------	--------------------------------

Tear Resistance

EN 388:2003	Level 4 (the highest possible)
-------------	--------------------------------

Dimensional Stability Test Achieved excellent results

CE Marking Cat II PPE Directive

Sizes S - XL

Clothing Care Machine washable up to 40° Celsius

Colour Choice of Black, Grey or Royal Blue

Place of Manufacture EU

Available in Black Grey Royal Blue

Description	S	M	L	XL
A Cuff width	10	11.5	13	14.5
B Sleeve length	23	26	29	29
C Elasticated arm cuff (relaxed)	14	15	16	17
D Arm width*	14	16	18	20

All measurements are taken flat in centimetres. All measurements are approximate and offered as a guideline only.
*Measured 14cm down from the elasticated cuff.



FOR ORDERS OF 1-5, PLEASE BUY ONLINE:

Visit our website: www.bite-pro.com

T: +44 (0) 845 5193 953 | E: info@bite-pro.com

Product: **BitePRO® Bite Resistant Arm Guards V2**

Model #: **100501**



BitePRO® Arm Guards (Version 2) are manufactured using Cut-Tex® PRO, our ground-breaking bite resistant material that prevents human teeth from penetrating the wearer's skin.

Features & Benefits

- Sold in pairs
- Excellent bite resistance
- Worn tight around the forearm
- 100% Latex free

Who Is This Product Suitable For?

Professionals working within these sectors:

- Mental Health Care
- Special Needs
- Special Education
- Challenging Behaviour
- Learning Disabilities
- Autism

Blade Cut Resistance

EN 388:2003	Level 5 (the highest possible)
ISO 13997:1999	Level 5 (the highest possible)
ASTM F 1790-05	Level 4

Abrasion Resistance

EN 388:2003	Level 4 (the highest possible)
-------------	--------------------------------

Tear Resistance

EN 388:2003	Level 4 (the highest possible)
Dimensional Stability Test	Achieved excellent results
CE Marking	Cat II PPE Directive
Sizes	S - XL
Clothing Care	Machine washable up to 40° Celsius
Colour	As per image, due to the nature of the technical fibres used
Place of Manufacture	EU

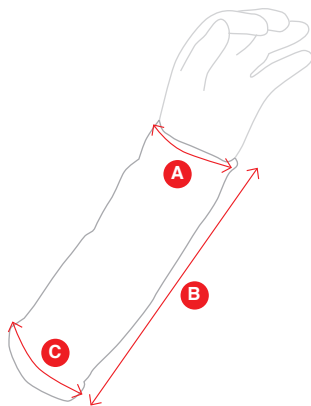

Description	S	M	L	XL
A Cuff width	9	10	11	12
B Sleeve length	22	24	25	26
C Arm width	11	12	13	14

All measurements are taken flat in centimetres. All measurements are approximate and offered as a guideline only.



FOR ORDERS OF 1-5, PLEASE BUY ONLINE:

Visit our website: www.bite-pro.com

T: +44 (0) 845 5193 953 | E: info@bite-pro.com

Product: **BitePRO® Bite Resistant Arm Guards V3**

Model #: **100504**



BitePRO® Arm Guards (Version 3) are manufactured using Cut-Tex® PRO, our ground-breaking bite resistant material that prevents human teeth from penetrating the wearer's skin.

Features & Benefits

- Sold in pairs
- Excellent bite resistance
- Worn tight around the forearm
- Also offering bite protection on inside and back of hand
- Thumbhole for improved fit
- 100% Latex free

Who Is This Product Suitable For?

Professionals working within these sectors:

- Mental Health Care
- Special Needs
- Special Education
- Challenging Behaviour
- Learning Disabilities
- Autism

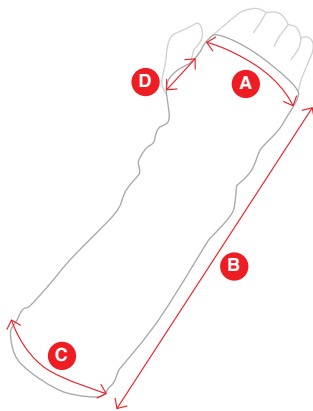

Blade Cut Resistance

EN 388:2003	Level 5 (the highest possible)
ISO 13997:1999	Level 5 (the highest possible)
ASTM F 1790-05	Level 4

Abrasion Resistance

EN 388:2003	Level 4 (the highest possible)
-------------	--------------------------------

Tear Resistance

EN 388:2003	Level 4 (the highest possible)
-------------	--------------------------------

Dimensional Stability Test	Achieved excellent results
----------------------------	----------------------------

CE Marking	Cat II PPE Directive
------------	----------------------

Sizes	S - XL
-------	--------

Clothing Care	Machine washable up to 40° Celsius
---------------	------------------------------------

Colour	As per image, due to the nature of the technical fibres used
--------	--

Place of Manufacture	EU
----------------------	----

Description	S	M	L	XL
A Cuff width	9	10	11	12
B Sleeve length	30	32	33	34
C Arm width	11	12	13	14
D Thumbhole opening	6	6	6	6

All measurements are taken flat in centimetres. All measurements are approximate and offered as a guideline only.



FOR ORDERS OF 1-5, PLEASE BUY ONLINE:

Visit our website: www.bite-pro.com

T: +44 (0) 845 5193 953 | E: info@bite-pro.com



Product: **BitePRO® Bite Resistant Full Arm Guards V4**

Model #: **100502**

BitePRO® Arm Guards (Version 4) are manufactured using Cut-Tex® PRO, our ground-breaking bite resistant material that prevents human teeth from penetrating the wearer's skin.

Available in



Features & Benefits

- Sold as one unit
- Overtly worn
- Excellent bite resistance
- Worn tight around the forearm
- Thumbhole for improved fit
- Quick and easy to put on
- Highly breathable inner lining
- Durable and water repellent outer material
- Thumb-loops to keep sleeves in perfect position even when arms are fully stretched or during high level of activity
- 100% Latex free

Who Is This Product Suitable For?

Professionals working within these sectors:

- Mental Health Care
- Special Needs
- Special Education
- Challenging Behaviour
- Learning Disabilities
- Autism

Blade Cut Resistance

EN 388:2003	Level 5 (the highest possible)
ISO 13997:1999	Level 5 (the highest possible)
ASTM F 1790-05	Level 4

Abrasion Resistance

EN 388:2003	Level 4 (the highest possible)
-------------	--------------------------------

Tear Resistance

EN 388:2003	Level 4 (the highest possible)
-------------	--------------------------------

Dimensional Stability Test	Achieved excellent results
----------------------------	----------------------------

CE Marking	Cat II PPE Directive
------------	----------------------

Sizes	S - XL
-------	--------

Clothing Care	Machine washable up to 40° Celsius
---------------	------------------------------------

Colour	Choice of Black, Grey or Royal Blue
--------	-------------------------------------

Place of Manufacture	EU
----------------------	----

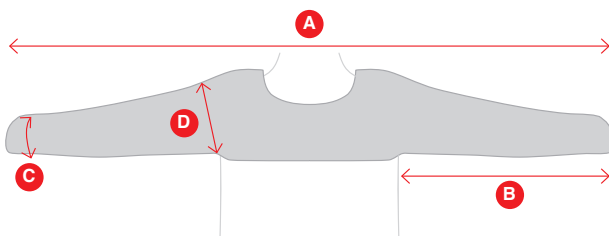

	Description	S	M	L	XL
A	Sleeve length	144	156	168	178
B	Sleeve under arm seam	48	50	55	60
C	Cuff opening	10	12	14	14
D	Arm hole opening	20	22	24	26

All measurements are taken flat in centimetres. All measurements are approximate and offered as a guideline only.



FOR ORDERS OF 1-5, PLEASE BUY ONLINE:

Visit our website: www.bite-pro.com

T: +44 (0) 845 5193 953 | E: info@bite-pro.com



Product: **BitePRO® Bite Resistant Full Arm Guards V4 with Added Protection**

Model #: **100506**

BitePRO® Arm Guards (Version 4) are manufactured using Cut-Tex® PRO, our ground-breaking bite resistant material that prevents human teeth from penetrating the wearer's skin.

This particular model provides **additional protection** to prevent severe bruising and blunt forced trauma - using specially engineered impact absorbing foam.



ADDED PROTECTION

Features & Benefits

- Sold as one unit
- Overtly worn
- Excellent bite resistance
- Worn tight around the forearm
- Thumbhole for improved fit
- Quick and easy to put on
- Highly breathable inner lining
- Durable and water repellent outer material
- Thumb-loops to keep sleeves in perfect position even when arms are fully stretched or during high level of activity
- 100% Latex free
- Additional protection to prevent severe bruising and blunt forced trauma

Who Is This Product Suitable For?

Professionals working within these sectors:

- Mental Health Care
- Special Needs
- Special Education
- Challenging Behaviour
- Learning Disabilities
- Autism

Blade Cut Resistance

EN 388:2003	Level 5 (the highest possible)
ISO 13997:1999	Level 5 (the highest possible)
ASTM F 1790-05	Level 4

Abrasion Resistance

EN 388:2003	Level 4 (the highest possible)
-------------	--------------------------------

Tear Resistance

EN 388:2003	Level 4 (the highest possible)
-------------	--------------------------------

CE Marking	Cat II PPE Directive
------------	----------------------

Sizes	S - XL
-------	--------

Clothing Care	Machine washable up to 40° Celsius
---------------	------------------------------------

Colour	Black
--------	-------

Place of Manufacture	EU
----------------------	----

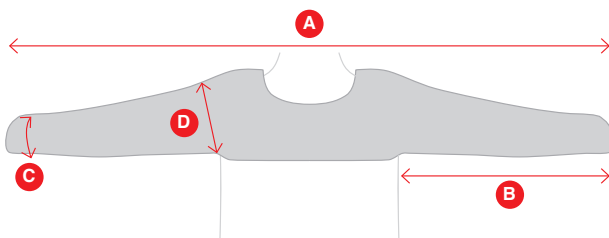

Description	S	M	L	XL
A Sleeve length	144	156	168	178
B Sleeve under arm seam	48	50	55	60
C Cuff opening	10	12	14	14
D Arm hole opening	20	22	24	26



FOR ORDERS OF 1-5, PLEASE BUY ONLINE:

Visit our website: www.bite-pro.com

T: +44 (0) 845 5193 953 | E: info@bite-pro.com



Product: **BitePRO® Bite Resistant Arm Guards V5**

Model #: **100505**



BitePRO® Arm Guards (Version 5) are manufactured using Cut-Tex® PRO, our ground-breaking bite resistant material that prevents human teeth from penetrating the wearer's skin.

Features & Benefits

- Sold as one unit
- Can be worn both overtly or covertly
- Excellent bite resistance
- Worn tight around the forearm
- Also offering bite protection on inside and back of hand
- Thumbhole for improved fit
- 100% Latex free

Who Is This Product Suitable For?

Professionals working within these sectors:

- Mental Health Care
- Special Needs
- Special Education
- Challenging Behaviour
- Learning Disabilities
- Autism

Blade Cut Resistance

EN 388:2003 Level 5 (the highest possible)

ISO 13997:1999 Level 5 (the highest possible)

ASTM F 1790-05 Level 4

Abrasion Resistance

EN 388:2003 Level 4 (the highest possible)

Tear Resistance

EN 388:2003 Level 4 (the highest possible)

Dimensional Stability Test Achieved excellent results

CE Marking Cat II PPE Directive

Sizes S - XL

Clothing Care Machine washable up to 40° Celsius

Colour As per image, due to the nature of the technical fibres used

Place of Manufacture EU

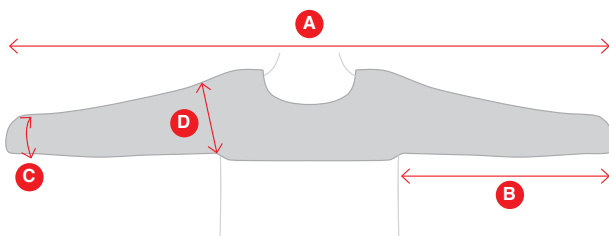

	Description	S	M	L	XL
A	Sleeve length	150	163	175	185
B	Sleeve under arm seam	50	53	58	63
C	Cuff opening	9	10	11	12
D	Arm hole opening	20	22	24	26

All measurements are taken flat in centimetres. All measurements are approximate and offered as a guideline only.



Product: **BitePRO® Bite Resistant Arm Guard Shirt**

Model #: **100120**

BitePRO® Arm Guard Shirts are manufactured using Cut-Tex® PRO, our ground-breaking bite resistant material that prevents human teeth from penetrating the wearer's skin.

This garment is ideal for professionals requiring protection from human bites along the arm area, for the entire duration of their working day - compared to those only needing to wear bite resistant arm guards for a limited period of time every day, or during specific incidents.



Features & Benefits

- Cut-Tex® PRO lined on entire shoulder/arm area providing excellent bite protection
- Breathable high performance fabric on front and back panels
- 100% Latex free

Who Is This Product Suitable For?

Professionals working within these sectors:

- Mental Health Care
- Special Needs
- Special Education
- Challenging Behaviour
- Learning Disabilities
- Autism

Blade Cut Resistance

EN 388:2003	Level 5 (the highest possible)
ISO 13997:1999	Level 5 (the highest possible)
ASTM F 1790-05	Level 4

Abrasion Resistance

EN 388:2003	Level 4 (the highest possible)
-------------	--------------------------------

Tear Resistance

EN 388:2003	Level 4 (the highest possible)
Dimensional Stability Test	Achieved excellent results
CE Marking	Cat II PPE Directive
Sizes	S - 3XL
Clothing Care	Machine washable up to 40° Celsius
Colour	As per image, due to the nature of the technical fibres used
Place of Manufacture	EU

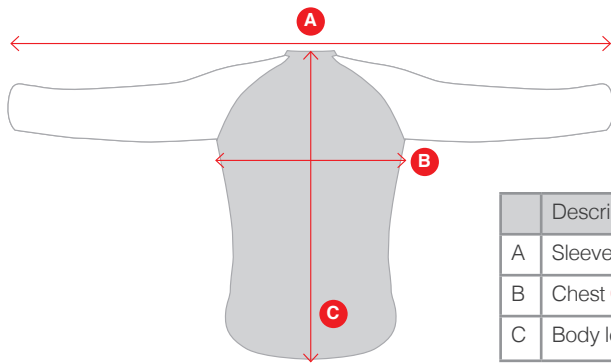

Description	S	M	L	XL	2XL	3XL
A Sleeve length	150	155	160	165	170	175
B Chest C	102	108	114	120	126	132
C Body length	69	72	75	78	81	84

All measurements are taken flat in centimetres, unless indicated with C. All measurements are approximate and offered as a guideline only. C = Circumference measurement.



FOR ORDERS OF 1-5, PLEASE BUY ONLINE:

Visit our website: www.bite-pro.com

T: +44 (0) 845 5193 953 | E: info@bite-pro.com

Product: **BitePRO® Bite Resistant Turtleneck Jacket**

Model #: **100117**

BitePRO® Bite Resistant Jackets are manufactured using Cut-Tex® PRO, our ground-breaking bite resistant material that prevents human teeth from penetrating the wearer's skin.

Available in



Grey



Features & Benefits

- Cut-Tex® PRO used on the entire garment providing excellent bite resistance
- High neck prevents neck and vertebral arteries from being exposed
- Zipped front makes this garment more user friendly
- 100% Latex free

Who Is This Product Suitable For?

Professionals working within these sectors:

- Mental Health Care
- Special Needs
- Special Education
- Challenging Behaviour
- Learning Disabilities
- Autism

Material Content 100% Cut-Tex® PRO

Blade Cut Resistance

EN 388:2003	Level 5 (the highest possible)
ISO 13997:1999	Level 5 (the highest possible)
ASTM F 1790-05	Level 4

Abrasion Resistance

EN 388:2003	Level 4 (the highest possible)
-------------	--------------------------------

Tear Resistance

EN 388:2003	Level 4 (the highest possible)
-------------	--------------------------------

Dimensional Stability Test	Achieved excellent results
----------------------------	----------------------------

CE Marking	Cat II PPE Directive
------------	----------------------

Sizes	S - 4XL
-------	---------

Clothing Care	Machine washable up to 40° Celsius
---------------	------------------------------------

Colour	Grey
--------	------

Place of Manufacture	EU
----------------------	----

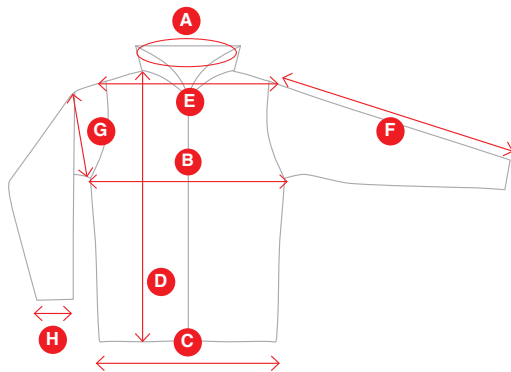

	Description	S	M	L	XL	2XL	3XL	4XL
A	Collar C	45.5	46.5	47.5	48.5	49.5	50.5	51.5
B	Chest	53	56	59	62	65	68	71
C	Hem	53	56	59	62	65	68	71
D	Front body length	69	72	75	78	81	84	87
E	Shoulder width	43	46	49	52	55	58	61
F	Sleeve overarm	60	62	64	66	67	68	68
G	Arm opening/hole	24	25	26	27	28	29	30
H	Sleeve cuff opening	10	10	11	11	12	13	14

All measurements are taken flat in centimetres, unless indicated with **C**. All measurements are approximate and offered as a guideline only. **C** = Circumference measurement.



FOR ORDERS OF 1-5, PLEASE BUY ONLINE:

Visit our website: www.bite-pro.com

T: +44 (0) 845 5193 953 | E: info@bite-pro.com

Product: **BitePRO® Bite Resistant Hoodie**

Model #: **100106**



BitePRO® Bite Resistant Hoodies are manufactured using Cut-Tex® PRO, our ground-breaking bite resistant material that prevents human teeth from penetrating the wearer's skin.

Available in



Grey

Features & Benefits

- Cut-Tex® PRO used on the entire garment providing excellent bite resistance
- 100% Latex free

Who Is This Product Suitable For?

Professionals working within these sectors:

- Mental Health Care
- Special Needs
- Special Education
- Challenging Behaviour
- Learning Disabilities
- Autism

Material Content 100% Cut-Tex® PRO

Blade Cut Resistance

EN 388:2003 Level 5 (the highest possible)

ISO 13997:1999 Level 5 (the highest possible)

ASTM F 1790-05 Level 4

Abrasion Resistance

EN 388:2003 Level 4 (the highest possible)

Tear Resistance

EN 388:2003 Level 4 (the highest possible)

Dimensional Stability Test Achieved excellent results

CE Marking Cat II PPE Directive

Sizes S - 3XL

Clothing Care Machine washable up to 40° Celsius

Colour Grey

Place of Manufacture EU

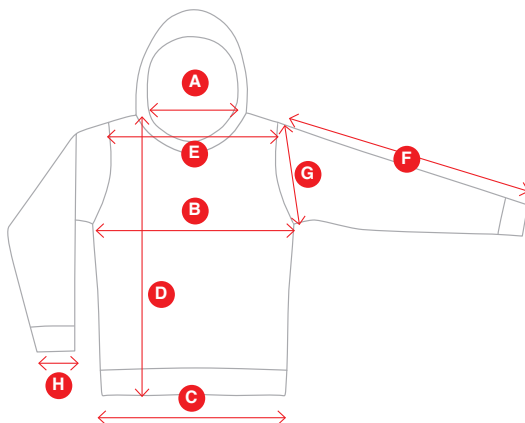

	Description	S	M	L	XL	2XL	3XL
A	Collar	15	16	17	18	19	20
B	Chest	50	52	54	56	60	64
C	Hem	51	53	55	57	61	65
D	Front body	64	66.5	69	71.5	74	76.5
E	Shoulder width	43	46	49	52	55	58
F	Sleeve overarm	61	62	63	64	65	66
G	Arm opening/hole	20	21	23	24	26	27
H	Sleeve cuff opening	8.5	9	9.5	10	10.5	11

All measurements are taken flat in centimetres. All measurements are approximate and offered as a guideline only.



FOR ORDERS OF 1-5, PLEASE BUY ONLINE:

Visit our website: www.bite-pro.com

T: +44 (0) 845 5193 953 | E: info@bite-pro.com

Product: **BitePRO® Bite Resistant Sweatshirt (Long Sleeve)**

Model #: **100109**



BitePRO® Bite Resistant Sweatshirts are manufactured using Cut-Tex® PRO, our ground-breaking bite resistant material that prevents human teeth from penetrating the wearer's skin.

Available in



Grey

Features & Benefits

- Cut-Tex® PRO used on the entire garment providing excellent bite resistance
- 100% Latex free

Who Is This Product Suitable For?

Professionals working within these sectors:

- Mental Health Care
- Special Needs
- Special Education
- Challenging Behaviour
- Learning Disabilities
- Autism

Material Content 100% Cut-Tex® PRO

Blade Cut Resistance

EN 388:2003 Level 5 (the highest possible)

ISO 13997:1999 Level 5 (the highest possible)

ASTM F 1790-05 Level 4

Abrasion Resistance

EN 388:2003 Level 4 (the highest possible)

Tear Resistance

EN 388:2003 Level 4 (the highest possible)

Dimensional Stability Test Achieved excellent results

CE Marking Cat II PPE Directive

Sizes S - 3XL

Clothing Care Machine washable up to 40° Celsius

Colour Grey

Place of Manufacture EU

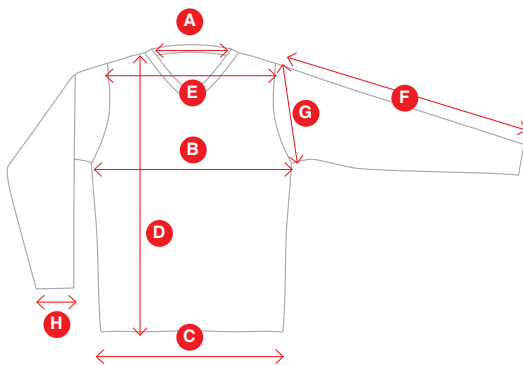

Description	S	M	L	XL	2XL	3XL
A Collar	15	16	17	18	19	20
B Chest	50	52	54	56	60	64
C Hem	50	52	54	56	60	64
D Front body	64	66.5	69	71.5	74	76.5
E Shoulder width	43	46	49	52	55	58
F Sleeve overarm	56	57	58	59	61	62
G Arm opening/hole	20	21	23	24	26	27
H Sleeve cuff opening	10	11	12	13	14	15

All measurements are taken flat in centimetres. All measurements are approximate and offered as a guideline only.



FOR ORDERS OF 1-5, PLEASE BUY ONLINE:

Visit our website: www.bite-pro.com

T: +44 (0) 845 5193 953 | E: info@bite-pro.com

Product: **BitePRO® Bite Resistant T Shirt**

Model #: **100108**

BitePRO® Bite Resistant T-Shirts are manufactured using Cut-Tex® PRO, our ground-breaking bite resistant material that prevents human teeth from penetrating the wearer's skin.

Available in



Grey



Features & Benefits

- Cut-Tex® PRO used on the entire garment providing excellent bite resistance
- 100% Latex free

Who Is This Product Suitable For?

Professionals working within these sectors:

- Mental Health Care
- Special Needs
- Special Education
- Challenging Behaviour
- Learning Disabilities
- Autism

Material Content 100% Cut-Tex® PRO

Blade Cut Resistance

EN 388:2003 Level 5 (the highest possible)

ISO 13997:1999 Level 5 (the highest possible)

ASTM F 1790-05 Level 4

Abrasion Resistance

EN 388:2003 Level 4 (the highest possible)

Tear Resistance

EN 388:2003 Level 4 (the highest possible)

Dimensional Stability Test Achieved excellent results

CE Marking Cat II PPE Directive

Sizes S - 3XL

Clothing Care Machine washable up to 40° Celsius

Colour Grey

Place of Manufacture EU

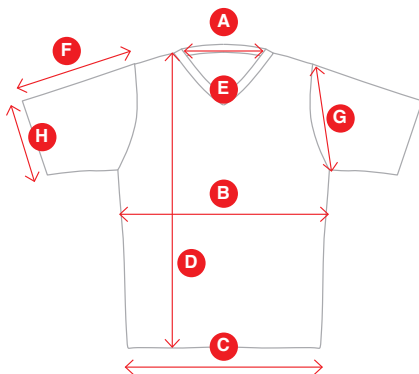

Description	S	M	L	XL	2XL	3XL
A Collar	15	16	17	18	19	20
B Chest	50	52	54	56	60	64
C Hem	51	53	55	57	61	65
D Front body	64	66.5	69	71.5	74	76.5
E Shoulder width	43	46	49	52	55	58
F Sleeve overarm	21	22	23	24	25	26
G Arm opening/hole	20	21	23	24	26	27
H Sleeve cuff opening	16	18	20	22	23	24

All measurements are taken flat in centimetres. All measurements are approximate and offered as a guideline only.



FOR ORDERS OF 1-5, PLEASE BUY ONLINE:

Visit our website: www.bite-pro.com

T: +44 (0) 845 5193 953 | E: info@bite-pro.com

Product: **BitePRO® Bite Resistant Polo Sweatshirt**

Model #: **100105**



BitePRO® Bite Resistant Polo Sweatshirts are manufactured using Cut-Tex® PRO, our ground-breaking bite resistant material that prevents human teeth from penetrating the wearer's skin.

Available in



Grey

Features & Benefits

- Cut-Tex® PRO used on the entire garment providing excellent bite resistance
- 100% Latex free

Who Is This Product Suitable For?

Professionals working within these sectors:

- Mental Health Care
- Special Needs
- Special Education
- Challenging Behaviour
- Learning Disabilities
- Autism

Material Content 100% Cut-Tex® PRO

Blade Cut Resistance

EN 388:2003 Level 5 (the highest possible)

ISO 13997:1999 Level 5 (the highest possible)

ASTM F 1790-05 Level 4

Abrasion Resistance

EN 388:2003 Level 4 (the highest possible)

Tear Resistance

EN 388:2003 Level 4 (the highest possible)

Dimensional Stability Test Achieved excellent results

CE Marking Cat II PPE Directive

Sizes S - 5XL

Clothing Care Machine washable up to 40° Celsius

Colour Grey

Place of Manufacture EU

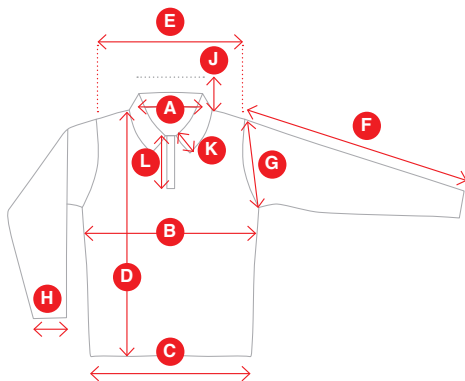

	Description	S	M	L	XL	2XL	3XL	4XL	5XL
A	Neck width	16.5	17	17.5	18	19	20	21	22
B	Chest	46	50	54	58	62	66	70	74
C	Hem	47	51	55	59	63	67	71	75
D	Front body*	70	72	74	75	76	77	78	79
E	Shoulder width	44	46	48	50	52	54	56	58
F	Sleeve overarm	60	61	62	63	64	65	66	68
G	Arm opening/hole	25	26	27	28	29	30	31	32
H	Sleeve cuff opening	11	11	12	12	12.5	13	13.5	14
J	Back collar height**	7.5	7.5	7.5	7.5	8	8	8	8
K	Front collar edge	6	6	6	6	6.5	6.5	6.5	6.5
L	Placket length	15.5	15.5	15.5	16	16	16	16.5	16.5
M	Placket width	3	3	3	3	3	3	4	4

All measurements are taken flat in centimetres. All measurements are approximate and offered as a guideline only.
*Length from neck point to hem. **Fully open.



FOR ORDERS OF 1-5, PLEASE BUY ONLINE:

Visit our website: www.bite-pro.com

T: +44 (0) 845 5193 953 | E: info@bite-pro.com

Product: **BitePRO® Bite Resistant Polo T Shirt**

Model #: **100104**



BitePRO® Bite Resistant Polo T-Shirts are manufactured using Cut-Tex® PRO, our ground-breaking bite resistant material that prevents human teeth from penetrating the wearer's skin.

Available in



Grey

Features & Benefits

- Cut-Tex® PRO used on the entire garment providing excellent bite resistance
- 100% Latex free

Who Is This Product Suitable For?

Professionals working within these sectors:

- Mental Health Care
- Special Needs
- Special Education
- Challenging Behaviour
- Learning Disabilities
- Autism

Material Content 100% Cut-Tex® PRO

Blade Cut Resistance

EN 388:2003 Level 5 (the highest possible)

ISO 13997:1999 Level 5 (the highest possible)

ASTM F 1790-05 Level 4

Abrasion Resistance

EN 388:2003 Level 4 (the highest possible)

Tear Resistance

EN 388:2003 Level 4 (the highest possible)

Dimensional Stability Test Achieved excellent results

CE Marking Cat II PPE Directive

Sizes S - 5XL

Clothing Care Machine washable up to 40° Celsius

Colour Grey

Place of Manufacture EU

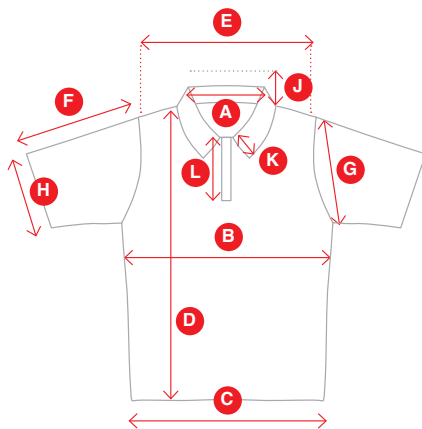

	Description	S	M	L	XL	2XL	3XL	4XL	5XL
A	Neck Width	16.5	17	17.5	18	19	20	21	22
B	Chest	46	50	54	58	62	66	70	74
C	Hem	47	51	55	59	63	67	71	75
D	Front Body*	70	72	74	75	76	77	78	79
E	Shoulder Width	44	46	48	50	52	54	56	58
F	Sleeve Overarm	21	22	23	24	25	26	27	28
G	Arm Opening/Hole	25	26	27	28	29	30	31	32
H	Sleeve Cuff Opening	15.5	16	17	18	19	20	21	22
J	Back Collar height**	7.5	7.5	7.5	7.5	8	8	8	8
K	Front collar edge	6	6	6	6	6.5	6.5	6.5	6.5
L	Placket Length	15.5	15.5	15.5	16	16	16	16.5	16.5
M	Placket Width	3	3	3	3	3	3	4	4

All measurements are taken flat in centimetres. All measurements are approximate and offered as a guideline only. *Length from neck point to hem. **Fully open.



FOR ORDERS OF 1-5, PLEASE BUY ONLINE:

Visit our website: www.bite-pro.com

T: +44 (0) 845 5193 953 | E: info@bite-pro.com

Product: **BitePRO® Front Only Body Armour**

Model #: **400118F (Female) | 400118M (Male)**



BitePRO® Front Only Body Armour is stab and blunt force trauma resistant - and protects the wearer from all main attacks targeting the front of the body.

Features & Benefits

- Concealable and lightweight
- Protects the most important front body parts - shields the spine, ribs and all vital organs
- Comfortably worn
- Easily put on and taken off within seconds
- Indefinite lifespan (compared to Kevlar's 3-5 year lifespan)

Who Is This Product Suitable For?

Professionals working within these sectors:

- Mental Health Care
- Special Needs
- Special Education
- Challenging Behaviour
- Learning Disabilities
- Autism



Material

3mm thin polycarbonate (same material used for riot shields) front plate, moulded to the upper body shape

Blunt Trauma Protection Good level of protection from high energy thrusts, impact based assaults (eg kicks, punches and blows) from any blunt object

Puncture Protection Good level of protection from narrower blades & hypodermic needles

Stab Protection 16 Joules - tested in-house

Sizes XS - 4XL

Weight 1KG (Size L)

Clothing Care Machine washable covers
Protective fillers can be easily removed within seconds prior to washing

Colour Black or White

Place of Manufacture UK

Size (EU)	Chest (inch/cm)		Waist (inch/cm)	
XS	30-32	76.2-81.28	26-28	66.04-71.12
S	34-36	86.36-91.44	28-30	71.12-76.2
M	38-40	96.52-101.60	32-34	81.28-86.36
L	42-44	106.88-111.76	36-38	91.44-96.52
XL	46-48	116.84-121.92	40-42	101.60-106.68
2XL	50-52	127-132.08	44-46	111.76-116.84
3XL	54-56	137.16-142.24	48-50	121.92-127
4XL	58-60	147.32-152.40	52-54	132.08-137.16

FOR ORDERS OF 1-5, PLEASE BUY ONLINE:

Visit our website: www.bite-pro.com

T: +44 (0) 845 5193 953 | E: info@bite-pro.com

Product: **BitePRO® Bite Resistant Boxer Shorts**

Model #: **200150**

BitePRO® Bite Resistant Boxer Shorts are manufactured using Cut-Tex® PRO, our ground-breaking bite resistant material that prevents human teeth from penetrating the wearer's skin.

Available in



Grey



Features & Benefits

- Excellent bite protection
- 100% Latex free

Who Is This Product Suitable For?

Professionals working within these sectors:

- Mental Health Care
- Special Needs
- Special Education
- Challenging Behaviour
- Learning Disabilities
- Autism

Material Content 100% Cut-Tex® PRO

Blade Cut Resistance

EN 388:2003 Level 5 (the highest possible)

ISO 13997:1999 Level 5 (the highest possible)

ASTM F 1790-05 Level 4

Abrasion Resistance

EN 388:2003 Level 4 (the highest possible)

Tear Resistance

EN 388:2003 Level 4 (the highest possible)

Dimensional Stability Test Achieved excellent results

CE Marking Cat II PPE Directive

Sizes S - 3XL

Clothing Care Machine washable up to 40° Celsius

Colour Grey

Place of Manufacture EU

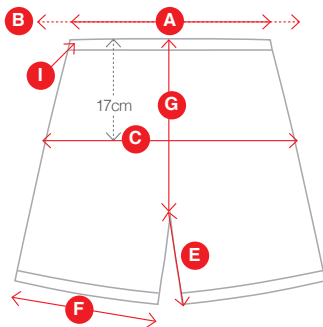

Description	S	M	L	XL	2XL	3XL
A Waist (relaxed)	30	34	38	42	46	50
B Waist (stretched)	45	49	53	57	61	65
C Hip - 17cm below waist	46	49	52	55	58	61
D Side leg length†	42	43	44	45	46	47
E Inside leg	20	20	20	20	20	20
F Leg opening	29	30	31	32	33	34
G Front rise†	28	29	30	31	32	33
H Back rise†	30	31	32	33	34	35
I Waist band depth	4	4	4	4	4	4

All measurements are taken flat in centimetres. All measurements are approximate and offered as a guideline only.
†Including waistband.



FOR ORDERS OF 1-5, PLEASE BUY ONLINE:

Visit our website: www.bite-pro.com

T: +44 (0) 845 5193 953 | E: info@bite-pro.com

Product: **BitePRO® Bite Resistant Long Johns**

Model #: **200102**



BitePRO® Bite Resistant Long Johns are manufactured using Cut-Tex® PRO, our ground-breaking bite resistant material that prevents human teeth from penetrating the wearer's skin.

Available in



Grey

Features & Benefits

- Excellent bite protection for the lower part of the body
- Slim fit
- Adjustable cord
- 100% Latex free

Who Is This Product Suitable For?

Professionals working within these sectors:

- Mental Health Care
- Special Needs
- Special Education
- Challenging Behaviour
- Learning Disabilities
- Autism

Material Content 100% Cut-Tex® PRO

Blade Cut Resistance

EN 388:2003 Level 5 (the highest possible)

ISO 13997:1999 Level 5 (the highest possible)

ASTM F 1790-05 Level 4

Abrasion Resistance

EN 388:2003 Level 4 (the highest possible)

Tear Resistance

EN 388:2003 Level 4 (the highest possible)

Dimensional Stability Test Achieved excellent results

CE Marking Cat II PPE Directive

Sizes S - 3XL

Clothing Care Machine washable up to 40° Celsius

Colour Grey

Place of Manufacture EU

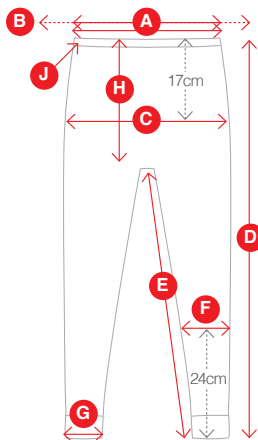

Description	S	M	L	XL	2XL	3XL
A Waist (relaxed)	30	34	38	42	46	50
B Waist (stretched)	45	49	53	57	61	65
C Hip - 17cm below waist	46	49	52	55	58	61
D Outside leg length†	100.5	101	101.5	102	102.5	103
E Inside leg	76.5	77	77.5	78	78.5	79
F Calf width	22	22.5	23	23.5	24	24.5
G Ankle width	14	14	16	16	18	18
H Front rise†	28	29	30	31	32	33
I Back rise†	30	31	32	33	34	35
J Waist band depth	4	4	4	4	4	4

All measurements are taken flat in centimetres. All measurements are approximate and offered as a guideline only.
†Including waistband.



FOR ORDERS OF 1-5, PLEASE BUY ONLINE:

Visit our website: www.bite-pro.com

T: +44 (0) 845 5193 953 | E: info@bite-pro.com

Product: **BitePRO® Bite Resistant Leg Guards (Version 1) with Added Protection**

Model #: **200200**

BitePRO® Bite Resistant Leg Guards are manufactured using Cut-Tex® PRO, our ground-breaking bite resistant material that prevents human teeth from penetrating the wearer's skin.



Features & Benefits

- Excellent bite protection for the lower part of the body
- Sold in pairs (left and right leg)
- Overtly worn
- Impact absorbing foam to whole leg area
- Durable water repellent outer material
- Easy to put on with inside zip fastening
- Adjustable cord and elastic fastening to top
- 100% Latex free

Who Is This Product Suitable For?

Professionals working within these sectors:

- Mental Health Care
- Special Needs
- Special Education
- Challenging Behaviour
- Learning Disabilities
- Autism

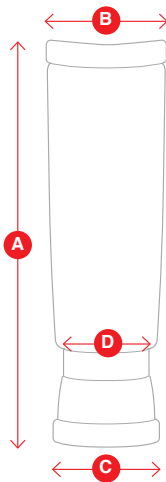

All measurements are taken flat in centimetres. All measurements are approximate and offered as a guideline only.

Blade Cut Resistance

EN 388:2003	Level 5 (the highest possible)
ISO 13997:1999	Level 5 (the highest possible)
ASTM F 1790-05	Level 4

Abrasion Resistance

EN 388:2003	Level 4 (the highest possible)
-------------	--------------------------------

Tear Resistance

EN 388:2003	Level 4 (the highest possible)
-------------	--------------------------------

Dimensional Stability Test	Achieved excellent results
----------------------------	----------------------------

CE Marking	Cat II PPE Directive
------------	----------------------

Sizes	S-XL
-------	------

Clothing Care	Machine washable up to 40° Celsius
---------------	------------------------------------

Colour	Black
--------	-------

Place of Manufacture	EU
----------------------	----

	Description	S	M	L	XL
A	Length	38	42	42	44
B	Top leg opening	22	24	26	28
C	Bottom leg opening	19	21	23	25
D	Ankle (10cm up from bottom leg)	14	16	18	20
E	Velcro patch height x length	10x4	10x4	10x4	10x4



FOR ORDERS OF 1-5, PLEASE BUY ONLINE:

Visit our website: www.bite-pro.com

T: +44 (0) 845 5193 953 | E: info@bite-pro.com



Product: **BitePRO® Bite Resistant Gloves Short**

Model #: **300161**

BitePRO® Gloves (Short) are manufactured using Cut-Tex® PRO, our ground-breaking bite resistant material that prevents human teeth from penetrating the wearer's skin.



Features & Benefits

- Excellent bite resistance
- Cut-Tex® PRO fully lined gauntlet cuff to protect the wearers wrist
- Soft durable polyester outer
- Synthetic leather lined palm to give secure grip
- Elasticated wrist to create a snug fit
- 100% Latex free

Who Is This Product Suitable For?

Professionals working within these sectors:

- Mental Health Care
- Special Needs
- Special Education
- Challenging Behaviour
- Learning Disabilities
- Autism

Blade Cut Resistance

EN 388:2003	Level 5 (the highest possible)
ISO 13997:1999	Level 5 (the highest possible)
ASTM F 1790-05	Level 4

Abrasion Resistance

EN 388:2003	Level 4 (the highest possible)
-------------	--------------------------------

Tear Resistance

EN 388:2003	Level 4 (the highest possible)
-------------	--------------------------------

Dimensional Stability Test	Achieved excellent results
----------------------------	----------------------------

CE Marking	Cat II PPE Directive
------------	----------------------

Sizes	XS - 2XL
-------	----------

Clothing Care	Machine washable up to 40° Celsius
---------------	------------------------------------

Colour	Grey
--------	------

1. Find Your Hand Width

Wrap a tailor's measuring tape around your dominant hand just below the knuckles, excluding your thumb, and make a fist. This is your 'hand width'.

EU Glove size	US Glove size	Inches	CMs
6	XS	6-7	15-17
7	S	7-8	17-20
8	M	8-9	20-22
9	L	9-10	22-25
10	XL	10-11	25-27
11	2XL	11+	28+

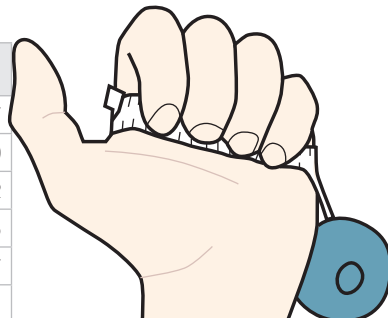

2. Find Your Hand Length

Measure from the bottom edge of your palm to the tip of your middle finger to find your 'finger length'.

EU Glove size	US Glove size	Inches	CMs
6	XS	6.5	16.5
7	S	7	18
8	M	7.5	19
9	L	8	20
10	XL	8.5	21.5
11	2XL	9	23

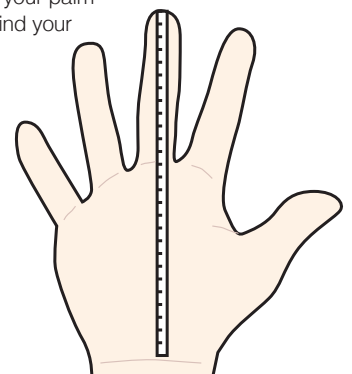

FOR ORDERS OF 1-5, PLEASE BUY ONLINE:

Visit our website: www.bite-pro.com

T: +44 (0) 845 5193 953 | E: info@bite-pro.com



Product: **BitePRO® Bite Resistant Gloves Long**

Model #: **300162**



BitePRO® Gloves (Long) are manufactured using Cut-Tex® PRO, our ground-breaking bite resistant material that prevents human teeth from penetrating the wearer's skin.



Features & Benefits

- Excellent bite resistance
- Cut-Tex PRO® lined sleeve to give full coverage and protection of the Radial artery
- Soft durable polyester outer
- Synthetic leather lined palm to give secure grip
- Elasticated wrist to create a snug fit
- 100% Latex free

Who Is This Product Suitable For?

Professionals working within these sectors:

- Mental Health Care
- Special Needs
- Special Education
- Challenging Behaviour
- Learning Disabilities
- Autism

Blade Cut Resistance

EN 388:2003	Level 5 (the highest possible)
ISO 13997:1999	Level 5 (the highest possible)
ASTM F 1790-05	Level 4

Abrasion Resistance

EN 388:2003	Level 4 (the highest possible)
-------------	--------------------------------

Tear Resistance

EN 388:2003	Level 4 (the highest possible)
-------------	--------------------------------

Dimensional Stability Test	Achieved excellent results
----------------------------	----------------------------

CE Marking	Cat II PPE Directive
------------	----------------------

Sizes	XS - 2XL
-------	----------

Clothing Care	Machine washable up to 40° Celsius
---------------	------------------------------------

Colour	Grey
--------	------

1. Find Your Hand Width

Wrap a tailor's measuring tape around your dominant hand just below the knuckles, excluding your thumb, and make a fist. This is your 'hand width'.

EU Glove size	US Glove size	Inches	CMs
6	XS	6-7	15-17
7	S	7-8	17-20
8	M	8-9	20-22
9	L	9-10	22-25
10	XL	10-11	25-27
11	2XL	11+	28+

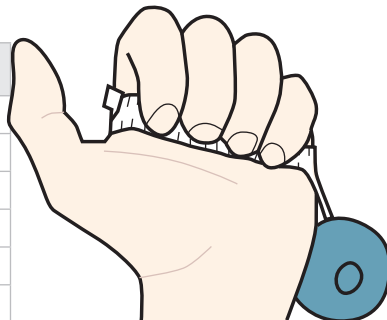

2. Find Your Hand Length

Measure from the bottom edge of your palm to the tip of your middle finger to find your 'finger length'.

EU Glove size	US Glove size	Inches	CMs
6	XS	6.5	16.5
7	S	7	18
8	M	7.5	19
9	L	8	20
10	XL	8.5	21.5
11	2XL	9	23

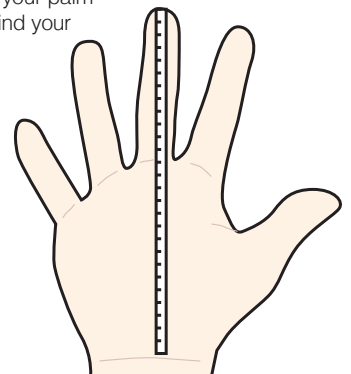

FOR ORDERS OF 1-5, PLEASE BUY ONLINE:

Visit our website: www.bite-pro.com

T: +44 (0) 845 5193 953 | E: info@bite-pro.com



Product: **BitePRO® Bite Resistant Fingerless Gloves**

Model #: **300163**



BitePRO® Fingerless Gloves are manufactured using Cut-Tex® PRO, our ground-breaking bite resistant material that prevents human teeth from penetrating the wearer's skin.



Features & Benefits

- Excellent bite resistance
- Cut-Tex PRO® lined sleeve to give full coverage and protection of the Radial artery
- Fingerless style for superior dexterity allowing for added control and precision
- Soft durable polyester outer & palm
- Elasticated wrist to create a snug fit
- 100% Latex free

Who Is This Product Suitable For?

Professionals working within these sectors:

- Mental Health Care
- Special Needs
- Special Education
- Challenging Behaviour
- Learning Disabilities
- Autism

Blade Cut Resistance

EN 388:2003	Level 5 (the highest possible)
ISO 13997:1999	Level 5 (the highest possible)
ASTM F 1790-05	Level 4

Abrasion Resistance

EN 388:2003	Level 4 (the highest possible)
-------------	--------------------------------

Tear Resistance

EN 388:2003	Level 4 (the highest possible)
-------------	--------------------------------

Dimensional Stability Test	Achieved excellent results
----------------------------	----------------------------

CE Marking	Cat II PPE Directive
------------	----------------------

Sizes	XS - 2XL
-------	----------

Clothing Care	Machine washable up to 40° Celsius
---------------	------------------------------------

Colour	Grey
--------	------

1. Find Your Hand Width

Wrap a tailor's measuring tape around your dominant hand just below the knuckles, excluding your thumb, and make a fist. This is your 'hand width'.

EU Glove size	US Glove size	Inches	CMs
6	XS	6-7	15-17
7	S	7-8	17-20
8	M	8-9	20-22
9	L	9-10	22-25
10	XL	10-11	25-27
11	2XL	11+	28+

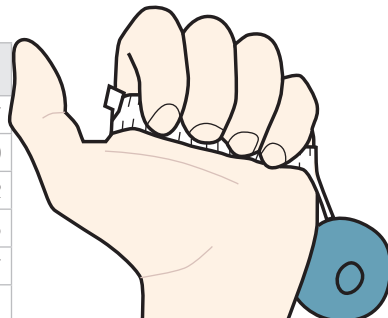

2. Find Your Hand Length

Measure from the bottom edge of your palm to the tip of your middle finger to find your 'finger length'.

EU Glove size	US Glove size	Inches	CMs
6	XS	6.5	16.5
7	S	7	18
8	M	7.5	19
9	L	8	20
10	XL	8.5	21.5
11	2XL	9	23

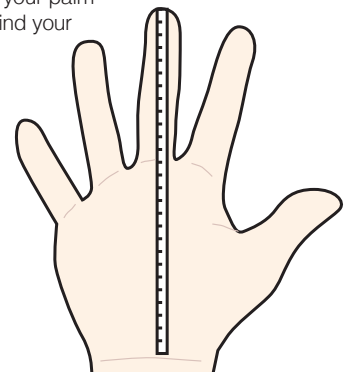

FOR ORDERS OF 1-5, PLEASE BUY ONLINE:

Visit our website: www.bite-pro.com

T: +44 (0) 845 5193 953 | E: info@bite-pro.com

Contact

PPSS Group

Whitfield Business Park
Unit 1-2, Manse Lane
Knaresborough
HG5 8BS
United Kingdom

T: **+44 (0) 845 5193 953**

E: **info@ppss-group.com**

W: **www.ppss-group.com**

FOR ORDERS OF 1-5, PLEASE BUY ONLINE:

Visit our website: www.bite-pro.com

T: +44 (0) 845 5193 953 | E: info@bite-pro.com

