

# SlashPRO® SLASH RESISTANT CLOTHING CATALOGUE 2020



SlashPRO®  
Clothing

# Contents

---

2. Introduction – SlashPRO® Slash Resistant Clothing
3. About Cut-Tex® PRO

## UPPER BODY

4. SlashPRO® Slash Resistant V-Neck T-Shirt
5. SlashPRO® Slash Resistant V-Neck Sweatshirt
6. SlashPRO® Slash Resistant Turtleneck Jacket
7. SlashPRO® Slash Resistant UBAC Shirt
8. SlashPRO® Slash Resistant Hoodie with Kangaroo Front Pocket
9. SlashPRO® Slash Resistant Turtleneck Sweatshirt with Thumbholes
10. SlashPRO® Slash Resistant Neck Guard
11. SlashPRO® Slash Resistant Body Armour Base Layer
12. SlashPRO® Slash Resistant Balaclava

## LOWER BODY

13. SlashPRO® Slash Resistant Boxer Shorts
14. SlashPRO® Slash Resistant Long Johns

## ARM GUARDS

15. SlashPRO® Slash Resistant Arm Guards V1
16. SlashPRO® Slash Resistant Arm Guards V2
17. SlashPRO® Slash Resistant Arm Guards V3
18. Contact

# SlashPRO® Slash Resistant Clothing

The risk of being slashed with an edged weapon is a harsh reality for those working for homeland security agencies, prisons and correctional facilities and within the private security sector.

Slash related injuries can often lead to rapid blood loss, subsequent shock and ultimately death, this is not to mention any long-term psychological trauma inflicted in case the injured person is surviving such assault.

There is no question about it, the number of assaults on frontline professionals are on the rise – so it pays to protect staff against the very worst-case scenarios. **SlashPRO® Slash Resistant Clothing** effectively helps to reduce the risks of slash related injuries. All garments offer BS EN 388:2016 Blade Cut Resistance Level E or Level 5 (the highest possible) based on the previous EN 388:2003 standard.

Please note, based on extensive research we know that more or less 100% of attackers with a knife will most like aim to stab the other person... however... due to the motions and movements of both parties, the majority of wounds are in fact slashing wounds. There is an unbelievable high number of 'ill reporting' going on. Many professionals incl medical staff conclude and/or report a 'knife wound' as 'stab wound'. This is unfortunately not the case and further education is needed.

Ian Horsfall and Mathew Arnold, of the Impact and Armour Group within the Department of Engineering and Applied Science at Cranfield University (Defence Academy of the United Kingdom) wrote a comprehensive piece on 'Protecting From Slash Knife Attacks'. A clear statement in this article reads:

*"A retrospective survey of hospital admissions data that contributed to the development of the standard suggested that 63 % of wounds attributable to sharp edged weapons were SLASH events."*

I have explained in a lengthy article "The Rise of Global Knife Crime" to the best I could, why more and more criminals carry knives and why more and more terrorists utilise knives to reach their misguided objectives. You, as a homeland security professional or enforcement agent, accept that anyone carrying a knife represents a real danger, even if he/she looks like he/she hasn't got a clue what he/she is actually doing.

Robert Kaiser, CEO  
PPSS Group



SlashPRO® Slash Resistant UBAC Shirt

## Why is SlashPRO® Clothing So Important?

- Attacks on police officers, who sustained injury, topped 7,903 in 2015. This was from a total of 23,000 reported to Health and Safety departments within police forces in the UK.
- In the USA, the FBI conducted a survey in 2013 on the number of officers assaulted with knives/blades. These were higher than the amount of attacks using firearms. This number has increased year on year up to the present day.
- Attacks in prisons are on the increase. There were 5,423 assaults on prison staff in the 12 months to the end of March 2016 - a rise of 40% on the previous year. This is only likely to increase further over the coming years.
- According to the 2013 Correctional Officer Wellness and Safety Literature Review, correctional officers are involved in the highest amount of non-fatal violent encounters than any other occupation.
- A study by the National Institute of Justice in 2007, discovered there are approximately 2,000 correctional staff member injuries annually due to violence against officers by inmates.
- The BBC reported in April 2014 that the number of serious attacks on UK prison officers by inmates increased by 45% in two years.
- A study in the US concluded that, in 2011, for every 10,000 full-time corrections officers, there were 254 workplace assaults and violent injuries - 36 times the rate for all American workers. In 2013, 15 workplace fatalities of correctional workers were reported nationwide, in a workforce of nearly 470,000 people.
- On 27th February 2016 the UK based Mirror Newspaper claimed that prisoners have assaulted more than 1,000 prison officers in just two months. These include 95 of the highest category 'serious' assaults on staff, such as being slashed with homemade weapons. The two monthly totals is equivalent to more than 16 prison officers being attacked each day. The figures show that 905 officers were victims of the lesser 'assault' during this period. This represented a surge of 15%.



Visit our website: [www.slash-pro.com](http://www.slash-pro.com)

T: +44 (0) 845 5193 953 | E: [info@slash-pro.com](mailto:info@slash-pro.com)

# About Cut-Tex<sup>®</sup> PRO

## Cut-Tex<sup>®</sup> PRO

The Ultimate Cut Protection<sup>™</sup>

Cut-Tex<sup>®</sup> PRO is an ultra-high performance cut, bite and slash resistant fabric, comfortable to wear, fully machine washable and of truly exceptional strength and durability - making it the ideal material for SlashPRO<sup>®</sup> Slash Resistant Clothing.

*As you can see below, Cut-Tex<sup>®</sup> PRO performs very highly in all cut, tear and abrasion tests:*

### Cut-Tex<sup>®</sup> PRO Performance Chart:

➤ **Cut Resistance** - ANSI/ISEA 2016 Blade Resistance Levels A1-A9



➤ **Abrasion Resistance** - EN 388:2016 Abrasion Resistance Levels 1-4



➤ **Cut Resistance** - EN 388:2003 (coupe test) Cut Resistance Levels 1-5



➤ **Tear Resistance** - EN 388:2016 Tear Resistance Levels 1-4



➤ **Puncture Resistance** - EN 388:2016 Puncture Resistance Levels 1-4



➤ **Cut Resistance** - EN ISO 13997 (TDM-100 Test)



Product: **SlashPRO® Slash Resistant T Shirt**

Model #: **100108**



SlashPRO® Slash Resistant T-Shirts are manufactured using Cut-Tex® PRO - offering absolutely outstanding, tested and certified levels of cut, abrasion and tear resistance.

### Features & Benefits

- Cut-Tex® PRO used on the entire garment providing excellent cut and slash resistance
- 100% Latex free

### Who Is This Product Suitable For?

Professionals working within these sectors:

- Law Enforcement
- Military
- Corrections / Prison Service
- Immigration
- Customs
- Border Control
- Private Security & Military Contractors
- Civil Enforcement

**Material Content** 100% Cut-Tex® PRO

### Blade Cut Resistance

EN 388:2016 Level 5

EN 388:2016 Level E (TDM-100 Test)

ISO 13997:1999 Level 5

ANSI/ISEA 2016 Level A5

### Tear Resistance

EN 388:2016 Level 4

### Puncture Resistance

EN 388:2016 Level 4

### Abrasion Resistance

EN 388:2016 Level 3

Dimensional Stability Test Achieved excellent results

Sizes S - 3XL

Clothing Care Machine washable up to 40° Celsius

Colour Grey

Place of Manufacture EU

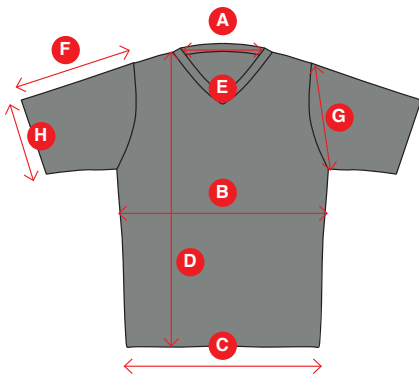

	Description	S	M	L	XL	2XL	3XL
A	Collar	15	16	17	18	19	20
B	Chest	50	52	54	56	60	64
C	Hem	51	53	55	57	61	65
D	Front body	64	66.5	69	71.5	74	76.5
E	Shoulder width	43	46	49	52	55	58
F	Sleeve overarm	21	22	23	24	25	26
G	Arm opening/hole	20	21	23	24	26	27
H	Sleeve cuff opening	16	18	20	22	23	24

All measurements are taken flat in centimetres. All measurements are approximate and offered as a guideline only.





Product: **SlashPRO® Slash Resistant Sweatshirt (Long Sleeve)**

Model #: **100109**



SlashPRO® Slash Resistant Sweatshirts are manufactured using Cut-Tex® PRO - offering absolutely outstanding, tested and certified levels of cut, abrasion and tear resistance.

**Features & Benefits**

- Cut-Tex® PRO used on the entire garment providing excellent cut and slash resistance
- 100% Latex free

**Who Is This Product Suitable For?**

Professionals working within these sectors:

- Law Enforcement
- Military
- Corrections / Prison Service
- Immigration
- Customs
- Border Control
- Private Security & Military Contractors
- Civil Enforcement

Material Content 100% Cut-Tex® PRO

**Blade Cut Resistance**

EN 388:2016	Level 5
EN 388:2016	Level E (TDM-100 Test)
ISO 13997:1999	Level 5
ANSI/ISEA 2016	Level A5

**Tear Resistance**

EN 388:2016 Level 4

**Puncture Resistance**

EN 388:2016 Level 4

**Abrasion Resistance**

EN 388:2016 Level 3

Dimensional Stability Test Achieved excellent results

Sizes S - 3XL

Clothing Care Machine washable up to 40° Celsius

Colour Grey

Place of Manufacture EU

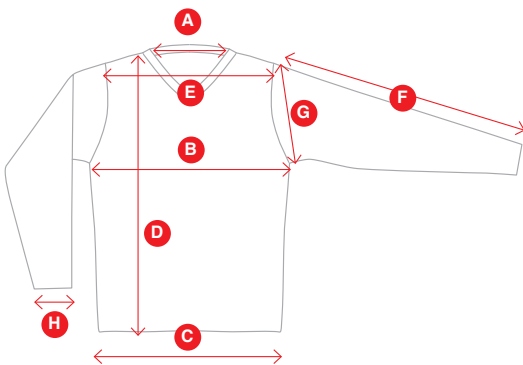

Description	S	M	L	XL	2XL	3XL
A Collar	15	16	17	18	19	20
B Chest	50	52	54	56	60	64
C Hem	50	52	54	56	60	64
D Front body	64	66.5	69	71.5	74	76.5
E Shoulder width	43	46	49	52	55	58
F Sleeve overarm	56	57	58	59	61	62
G Arm opening/hole	20	21	23	24	26	27
H Sleeve cuff opening	10	11	12	13	14	15

All measurements are taken flat in centimetres.  
All measurements are approximate and offered as a guideline only.



Visit our website: [www.slash-pro.com](http://www.slash-pro.com)

T: +44 (0) 845 5193 953 | E: [info@slash-pro.com](mailto:info@slash-pro.com)

Product: **SlashPRO® Slash Resistant Turtleneck Jacket**

Model #: 100117



SlashPRO® Slash Resistant Jackets are manufactured using Cut-Tex® PRO - offering absolutely outstanding, tested and certified levels of cut, abrasion and tear resistance.

### Features & Benefits

- Cut-Tex® PRO used on the entire garment providing excellent bite resistance
- High neck prevents neck and vertebral arteries from being exposed
- Zipped front makes this garment more user friendly
- 100% Latex free

### Who Is This Product Suitable For?

Professionals working within these sectors:

- Mental Health Care
- Special Needs
- Special Education
- Challenging Behaviour
- Learning Disabilities
- Autism

**Material Content** 100% Cut-Tex® PRO

### Blade Cut Resistance

EN 388:2016 Level 5

EN 388:2016 Level E (TDM-100 Test)

ISO 13997:1999 Level 5

ANSI/ISEA 2016 Level A5

### Tear Resistance

EN 388:2016 Level 4

### Puncture Resistance

EN 388:2016 Level 4

### Abrasion Resistance

EN 388:2016 Level 3

Dimensional Stability Test Achieved excellent results

Sizes S - 5XL

Clothing Care Machine washable up to 40° Celsius

Colour Grey

Place of Manufacture EU

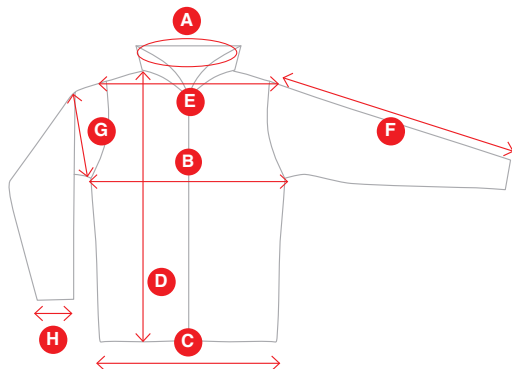

	Description	S	M	L	XL	2XL	3XL	4XL	5XL
A	Collar <b>C</b>	45.5	46.5	47.5	48.5	49.5	50.5	51.5	52.5
B	Chest	53	56	59	62	65	68	71	74
C	Hem	53	56	59	62	65	68	71	74
D	Front body length	69	72	75	78	81	84	87	90
E	Shoulder width	43	46	49	52	55	58	61	64
F	Sleeve overarm	60	62	64	66	67	68	68	69
G	Arm opening/hole	24	25	26	27	28	29	30	31
H	Sleeve cuff opening	10	10	11	11	12	13	14	15

All measurements are taken flat in centimetres, unless indicated with **C**.  
All measurements are approximate and offered as a guideline only.  
**C** = Circumference measurement.

Cut-Tex® PRO

Product: **SlashPRO® Slash Resistant UBAC Shirt**

Model #: **100115**

SlashPRO® Slash Resistant UBAC Shirts are manufactured using Cut-Tex® PRO - offering absolutely outstanding, tested and certified levels of cut, abrasion and tear resistance - providing an effective shield and protects areas often unguarded by common body armour e.g. key arteries from laceration and subsequent rapid blood loss.



### Features & Benefits

- Offering comfortable yet effective cut protection to the radial artery, brachial artery, carotid artery and axillary artery whilst wearing body armour. Laceration of either of these arteries can lead to rapid blood loss and potential death.
- Two upper arm pockets (for small notepad and pens) with Velcro for rank patches, blood patches or other attachments
- Machine washable
- Thumb loops to keep sleeves in place
- 100% Latex free

### Who Is This Product Suitable For?

Professionals working within these sectors:

- Law Enforcement
- Military
- Corrections / Prison Service
- Immigration
- Customs
- Border Control
- Private Security & Military Contractors
- Civil Enforcement

### Material Content

100% Cut-Tex® PRO + 100% Polyester

### Blade Cut Resistance

EN 388:2016 Level 5

EN 388:2016 Level E (TDM-100 Test)

ISO 13997:1999 Level 5

ANSI/ISEA 2016 Level A5

### Tear Resistance

EN 388:2016 Level 4

### Puncture Resistance

EN 388:2016 Level 4

### Abrasion Resistance

EN 388:2016 Level 3

Dimensional Stability Test Achieved excellent results

Sizes S - 3XL

Clothing Care Machine washable up to 40° Celsius

Colour Grey

Place of Manufacture EU

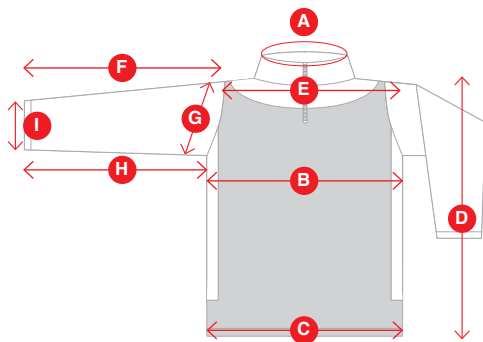

	Description	S	M	L	XL	2XL	3XL
A	Collar <b>C</b>	44.5	45	45.5	46	46.5	47
B	Chest	51	54	57	60	63	66
C	Hem	51	54	57	60	63	66
D	Front Body †	69	72	75	78	81	84
E	Shoulder Width	43	46	49	52	55	58
F	Sleeve Overarm	61	62	63	64	65	66
G	Arm Opening/Hole	20	21	22	23	24	25
H	Under Arm Length	46.5	48	49.5	51	52.5	54
I	Sleeve Cuff Opening	11	12	13	14	15	16

All measurements are taken flat in centimetres, unless indicated with **C**.  
All measurements are approximate and offered as a guideline only.  
**C** = Circumference measurement. † = Length from neck point to hem.

**Cut-Tex® PRO**



Product: **SlashPRO® Slash Resistant Hoodie with Kangaroo Front Pocket**

Model #: **100102**



SlashPRO® Slash Resistant Hoodies are manufactured using Cut-Tex® PRO - offering absolutely outstanding, tested and certified levels of cut, abrasion and tear resistance.

### Features & Benefits

- Cut-Tex® PRO used on the entire garment providing excellent cut and slash resistance
- 100% Latex free

### Who Is This Product Suitable For?

Professionals working within these sectors:

- Law Enforcement
- Military
- Corrections / Prison Service
- Immigration
- Customs
- Border Control
- Private Security & Military Contractors
- Civil Enforcement

### Material Content

100% Cut-Tex® PRO + 100% Polyester

### Blade Cut Resistance

EN 388:2016 Level 5

EN 388:2016 Level E (TDM-100 Test)

ISO 13997:1999 Level 5

ANSI/ISEA 2016 Level A5

### Tear Resistance

EN 388:2016 Level 4

### Puncture Resistance

EN 388:2016 Level 4

### Abrasion Resistance

EN 388:2016 Level 3

Dimensional Stability Test Achieved excellent results

Sizes S - 3XL

Clothing Care Machine washable up to 40° Celsius

Colour Grey

Place of Manufacture EU

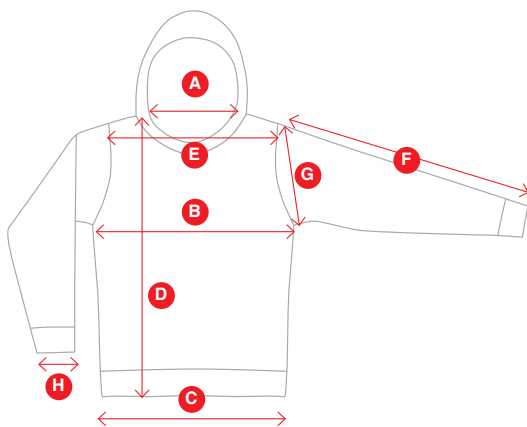

	Description	S	M	L	XL	2XL	3XL
A	Collar	15	16	17	18	19	20
B	Chest	50	52	54	56	60	64
C	Hem	51	53	55	57	61	65
D	Front body	64	66.5	69	71.5	74	76.5
E	Shoulder width	43	46	49	52	55	58
F	Sleeve overarm	61	62	63	64	65	66
G	Arm opening/hole	20	21	23	24	26	27
H	Sleeve cuff opening	8.5	9	9.5	10	10.5	11

All measurements are taken flat in centimetres. All measurements are approximate and offered as a guideline only.

**Cut-Tex® PRO**



Product: **SlashPRO® Slash Resistant Turtleneck Sweatshirt with Thumbholes**

Model #: **100107**



SlashPRO® Slash Resistant Sweatshirts are manufactured using Cut-Tex® PRO - offering absolutely outstanding, tested and certified levels of cut, abrasion and tear resistance.

**Features & Benefits**

- Cut-Tex® PRO used on the entire garment providing excellent cut and slash resistance
- High neck prevents neck and vertebral arteries from being exposed
- Thumbhole sleeves prevent the wrist and radial artery from being exposed
- 100% Latex free

**Who Is This Product Suitable For?**

Professionals working within these sectors:

- Law Enforcement
- Military
- Corrections / Prison Service
- Immigration
- Customs
- Border Control
- Private Security & Military Contractors
- Civil Enforcement

**Material Content**

100% Cut-Tex® PRO + 100% Polyester

**Blade Cut Resistance**

EN 388:2016	Level 5
EN 388:2016	Level E (TDM-100 Test)
ISO 13997:1999	Level 5
ANSI/ISEA 2016	Level A5

**Tear Resistance**

EN 388:2016	Level 4
-------------	---------

**Puncture Resistance**

EN 388:2016	Level 4
-------------	---------

**Abrasion Resistance**

EN 388:2016	Level 3
-------------	---------

Dimensional Stability Test Achieved excellent results

Sizes S - 3XL

Clothing Care Machine washable up to 40° Celsius

Colour Grey

Place of Manufacture EU

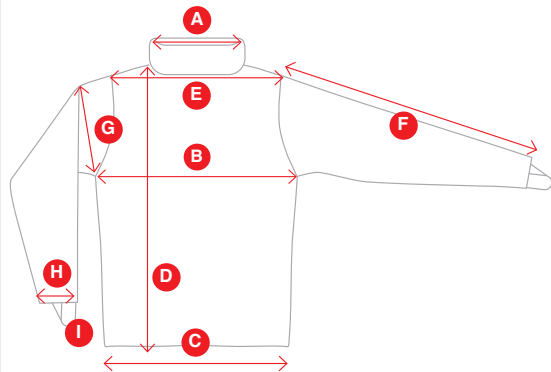

	Description	S	M	L	XL	2XL	3XL
A	Collar	18	19	20	21	22	23
B	Chest	50	52	54	56	60	64
C	Hem	50	52	54	56	60	64
D	Front body length	64	66.5	69	71.5	74	76.5
E	Shoulder width	43	46	49	52	55	58
F	Sleeve overarm	62	62	64	64	66	68
G	Arm opening/hole	20	21	23	24	26	28
H	Sleeve cuff opening	10	11	12	13	14	15
I	Thumbhole	5	5	5	5	5.5	5.5

All measurements are taken flat in centimetres.  
All measurements are approximate and offered as a guideline only.



Visit our website: [www.slash-pro.com](http://www.slash-pro.com)

T: +44 (0) 845 5193 953 | E: [info@slash-pro.com](mailto:info@slash-pro.com)

Product: **SlashPRO® Slash Resistant Neck Guard**

Model #: **100110**

SlashPRO® Slash Resistant Neck Guards are manufactured using Cut-Tex® PRO which acts as an effective shield and protects areas often unguarded by common body armour.



### Features & Benefits

- Offering comfortable yet effective cut protection to the carotid artery, an area even exposed whilst wearing any type of body armour. Laceration of this artery can lead to rapid blood loss and potential death.
- Wrapped in black polyester
- Folding down collar
- Machine washable
- 100% Latex free

### Who Is This Product Suitable For?

Professionals working within these sectors:

- Law Enforcement
- Military
- Corrections / Prison Service
- Immigration
- Customs
- Border Control
- Private Security & Military Contractors
- Civil Enforcement

### Find Your Size

Please use this chart as a guide. Measure the circumference of your head just above the brow line.

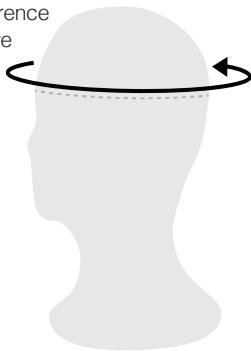

Size	Head circumference
<b>S</b>	<b>50-52cm</b>
<b>M</b>	<b>53-55cm</b>
<b>L</b>	<b>56-58cm</b>
<b>XL</b>	<b>59-61cm</b>
<b>XXL</b>	<b>62-64cm</b>

### Material Content

100% Cut-Tex® PRO + 100% Polyester

### Blade Cut Resistance

EN 388:2016	Level 5
EN 388:2016	Level E (TDM-100 Test)
ISO 13997:1999	Level 5
ANSI/ISEA 2016	Level A5

### Tear Resistance

EN 388:2016	Level 4
-------------	---------

### Puncture Resistance

EN 388:2016	Level 4
-------------	---------

### Abrasion Resistance

EN 388:2016	Level 3
-------------	---------

Dimensional Stability Test Achieved excellent results

Sizes S - 2XL

Clothing Care Machine washable up to 40° Celsius

Colour Black

Place of Manufacture EU

Size	A: Neck side point to point	B: Centre front length	C: Shoulder width
S	23cm	18cm	38cm
M	24cm	19cm	39cm
L	25cm	20cm	40cm
XL	26cm	21cm	41cm
XXL	27cm	22cm	42cm

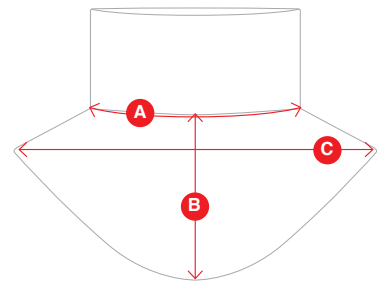

All measurements are taken flat in centimetres. All measurements are approximate and offered as a guideline only.

\*Length from neck point to hem. \*\*Fully open.

Product: **SlashPRO® Slash Resistant Body Armour  
Base Layer**

Model #: **100112**



SlashPRO® Slash Resistant Body Armour Base Layers are manufactured using Cut-Tex® PRO - offering absolutely outstanding, tested and certified levels of cut, abrasion and tear resistance.

### Features & Benefits

- Cut-Tex® PRO used under the arm and the unprotected sides of the upper body - providing excellent cut and slash resistance
- 100% Latex free

### Who Is This Product Suitable For?

Professionals working within these sectors:

- Law Enforcement
- Military
- Corrections / Prison Service
- Immigration
- Customs
- Border Control
- Private Security & Military Contractors
- Civil Enforcement

### Material Content

100% Cut-Tex® PRO + 100% Polyester

### Blade Cut Resistance

EN 388:2016 Level 5

EN 388:2016 Level E (TDM-100 Test)

ISO 13997:1999 Level 5

ANSI/ISEA 2016 Level A5

### Tear Resistance

EN 388:2016 Level 4

### Puncture Resistance

EN 388:2016 Level 4

### Abrasion Resistance

EN 388:2016 Level 3

Dimensional Stability Test Achieved excellent results

Sizes S - 3XL

Clothing Care Machine washable up to 40° Celsius

Colour Grey

Place of Manufacture EU

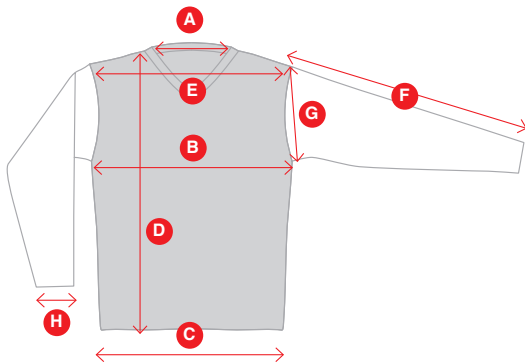

Description	S	M	L	XL	2XL	3XL
A Collar <b>C</b>	42.5	43	43.5	44	44.5	45
B Chest	51	54	57	60	63	66
C Hem	51	54	57	60	63	66
D Front body length	69	72	75	78	81	84
E Shoulder width	43	46	49	52	55	58
F Sleeve overarm	57	58	59	60	61	62
G Arm opening/hole	20	21	22	23	24	25
H Sleeve cuff opening	11	12	13	14	15	16

All measurements are taken flat in centimetres, unless indicated with **C**.  
All measurements are approximate and offered as a guideline only.  
**C** = Circumference measurement.

Cut-Tex® PRO

Product: **SlashPRO<sup>®</sup> Slash Resistant Balaclava**

Model #: **100121**



SlashPRO<sup>®</sup> Slash Resistant Balaclavas are manufactured using Cut-Tex<sup>®</sup> PRO - offering absolutely outstanding, tested and certified levels of cut, abrasion and tear resistance.

### Features & Benefits

- Cut-Tex<sup>®</sup> PRO used on the entire garment providing excellent cut and slash resistance
- Ideal for forced entry operations and riot teams
- Effectively protecting Carotid Artery
- 100% Latex free

### Who Is This Product Suitable For?

Professionals working within these sectors:

- Law Enforcement
- Military
- Corrections / Prison Service
- Immigration
- Customs
- Border Control
- Private Security & Military Contractors
- Civil Enforcement

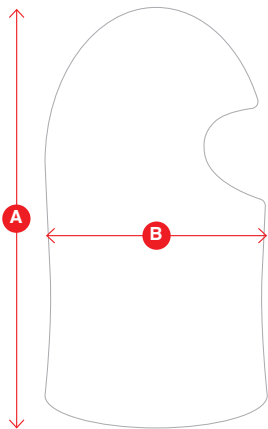

Material Content 100% Cut-Tex<sup>®</sup> PRO + 100% Polyester

### Blade Cut Resistance

EN 388:2016 Level 5

EN 388:2016 Level E (TDM-100 Test)

ISO 13997:1999 Level 5

ANSI/ISEA 2016 Level A5

### Tear Resistance

EN 388:2016 Level 4

### Puncture Resistance

EN 388:2016 Level 4

### Abrasion Resistance

EN 388:2016 Level 3

Dimensional Stability Test Achieved excellent results

Sizes S - 2XL

Clothing Care Machine washable up to 40° Celsius

Colour Grey

Place of Manufacture EU

	Description	S/M	L/XL	2XL/3XL
A	Height	43	45	47
B	Width	24	26	28

**Cut-Tex<sup>®</sup> PRO**

Product: **SlashPRO® Slash Resistant Boxer Shorts**

Model #: **200150**

SlashPRO® Slash Resistant Boxer Shorts are manufactured using Cut-Tex® PRO - offering absolutely outstanding, tested and certified levels of cut, abrasion and tear resistance.



### Features & Benefits

- Excellent cut and slash protection
- 100% Latex free

### Who Is This Product Suitable For?

Professionals working within these sectors:

- Law Enforcement
- Military
- Corrections / Prison Service
- Immigration
- Customs
- Border Control
- Private Security & Military Contractors
- Civil Enforcement

### Material Content

100% Cut-Tex® PRO + 100% Polyester

### Blade Cut Resistance

EN 388:2016 Level 5

EN 388:2016 Level E (TDM-100 Test)

ISO 13997:1999 Level 5

ANSI/ISEA 2016 Level A5

### Tear Resistance

EN 388:2016 Level 4

### Puncture Resistance

EN 388:2016 Level 4

### Abrasion Resistance

EN 388:2016 Level 3

Dimensional Stability Test Achieved excellent results

Sizes S - 3XL

Clothing Care Machine washable up to 40° Celsius

Colour Grey

Place of Manufacture EU

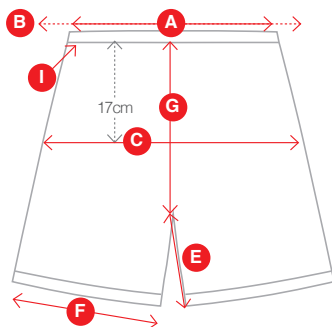

Description	S	M	L	XL	2XL	3XL
A Waist (relaxed)	30	34	38	42	46	50
B Waist (stretched)	45	49	53	57	61	65
C Hip - 17cm below waist	46	49	52	55	58	61
D Side leg length†	42	43	44	45	46	47
E Inside leg	20	20	20	20	20	20
F Leg opening	29	30	31	32	33	34
G Front rise†	28	29	30	31	32	33
H Back rise†	30	31	32	33	34	35
I Waist band depth	4	4	4	4	4	4

All measurements are taken flat in centimetres.  
All measurements are approximate and offered as a guideline only.

†Including waistband.

**Cut-Tex® PRO**

Product: **SlashPRO® Slash Resistant Long Johns**

Model #: **200102**



SlashPRO® Slash Resistant Long Johns are manufactured using Cut-Tex® PRO - offering absolutely outstanding, tested and certified levels of cut, abrasion and tear resistance.

### Features & Benefits

- Excellent cut and slash protection for the lower part of the body
- Slim fit
- Adjustable cord
- 100% Latex free

### Who Is This Product Suitable For?

Professionals working within these sectors:

- Law Enforcement
- Military
- Corrections / Prison Service
- Immigration
- Customs
- Border Control
- Private Security & Military Contractors
- Civil Enforcement

**Material Content** 100% Cut-Tex® PRO + 100% Polyester

### Blade Cut Resistance

EN 388:2016	Level 5
EN 388:2016	Level E (TDM-100 Test)
ISO 13997:1999	Level 5
ANSI/ISEA 2016	Level A5

### Tear Resistance

EN 388:2016	Level 4
-------------	---------

### Puncture Resistance

EN 388:2016	Level 4
-------------	---------

### Abrasion Resistance

EN 388:2016	Level 3
-------------	---------

Dimensional Stability Test Achieved excellent results

Sizes S - 3XL

Clothing Care Machine washable up to 40° Celsius

Colour Grey

Place of Manufacture EU

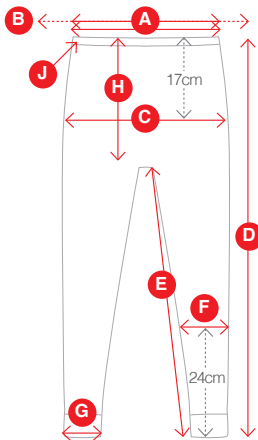

Description	S	M	L	XL	2XL	3XL
A Waist (relaxed)	30	34	38	42	46	50
B Waist (stretched)	45	49	53	57	61	65
C Hip - 17cm below waist	46	49	52	55	58	61
D Outside leg length†	99	100	101	102	103	104
E Inside leg	76.5	77	77.5	78	78.5	79
F Calf width	22	22.5	23	23.5	24	24.5
G Ankle width	14	14	16	16	18	18
H Front rise†	28	29	30	31	32	33
I Back rise†	30	31	32	33	34	35
J Waist band depth	4	4	4	4	4	4

All measurements are taken flat in centimetres.  
All measurements are approximate and offered as a guideline only.  
†Including waistband.

**Cut-Tex® PRO**

Product: **SlashPRO® Slash Resistant Arm Guards V1**

Model #: **100500**

SlashPRO® Arm Guards (Version 1) are manufactured using Cut-Tex® PRO - offering absolutely outstanding, tested and certified levels of cut, abrasion and tear resistance.



### Features & Benefits

- Sold in pairs
- Overtly worn
- Excellent cut and slash resistance
- Thumbhole for improved fit
- Quick and easy to put on
- Highly breathable inner lining
- Durable and water repellent outer material
- 100% Latex free
- Also available as model with additional outstanding protection from severe bruising and blunt forced trauma - Model 100503

### Who Is This Product Suitable For?

Professionals working within these sectors:

- Law Enforcement
- Military
- Corrections / Prison Service
- Immigration
- Customs
- Border Control
- Private Security & Military Contractors
- Civil Enforcement

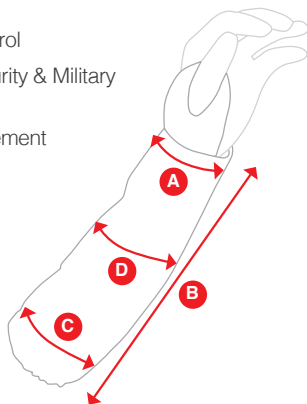

All measurements are taken flat in centimetres.  
All measurements are approximate and offered as a guideline only.  
\*Measured 14cm down from the elasticated cuff.

### Blade Cut Resistance

EN 388:2016 Level 5

EN 388:2016 Level E (TDM-100 Test)

ISO 13997:1999 Level 5

ANSI/ISEA 2016 Level A5

### Tear Resistance

EN 388:2016 Level 4

### Puncture Resistance

EN 388:2016 Level 4

### Abrasion Resistance

EN 388:2016 Level 3

Dimensional Stability Test Achieved excellent results

CE Marking Cat II PPE Directive

Sizes S - XL

Clothing Care Machine washable up to 40° Celsius

Colour Black

Place of Manufacture EU

	Description	S	M	L	XL
A	Cuff width	10	11	12	13
B	Sleeve length	23	26	29	29
C	Elasticated arm cuff (relaxed)	11	13	15	17
D	Arm width*	13	15	17	19



Product: **SlashPRO® Slash Resistant Arm Guards V2**

Model #: **100501**



SlashPRO® Arm Guards (Version 2) are manufactured using Cut-Tex® PRO - offering absolutely outstanding, tested and certified levels of cut, abrasion and tear resistance.

### Features & Benefits

- Sold in pairs
- Excellent cut and slash resistance
- Worn tight around the forearm
- 100% Latex free

### Who Is This Product Suitable For?

Professionals working within these sectors:

- Law Enforcement
- Military
- Corrections / Prison Service
- Immigration
- Customs
- Border Control
- Private Security & Military Contractors
- Civil Enforcement

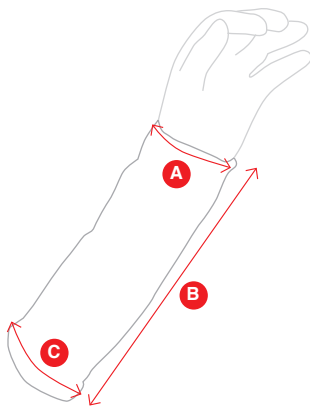

All measurements are taken flat in centimetres.  
All measurements are approximate and offered as a guideline only.

### Blade Cut Resistance

EN 388:2016 Level 5

EN 388:2016 Level E (TDM-100 Test)

ISO 13997:1999 Level 5

ANSI/ISEA 2016 Level A5

### Tear Resistance

EN 388:2016 Level 4

### Puncture Resistance

EN 388:2016 Level 4

### Abrasion Resistance

EN 388:2016 Level 3

Dimensional Stability Test Achieved excellent results

CE Marking Cat II PPE Directive

Sizes S - XL

Clothing Care Machine washable up to 40° Celsius

Colour Grey

Place of Manufacture EU

Description	S	M	L	XL
A Cuff width	9	10	11	12
B Sleeve length	22	24	25	26
C Arm width	11	12	13	14

Product: **SlashPRO® Slash Resistant Arm Guards V3**

Model #: **100504**

SlashPRO® Arm Guards (Version 3) are manufactured using Cut-Tex® PRO - offering absolutely outstanding, tested and certified levels of cut, abrasion and tear resistance.



### Features & Benefits

- Sold in pairs
- Excellent cut and slash resistance
- Worn tight around the forearm
- Also offering bite protection on inside and back of hand
- Thumbhole for improved fit
- 100% Latex free

### Who Is This Product Suitable For?

Professionals working within these sectors:

- Law Enforcement
- Military
- Corrections / Prison Service
- Immigration
- Customs
- Border Control
- Private Security & Military Contractors
- Civil Enforcement

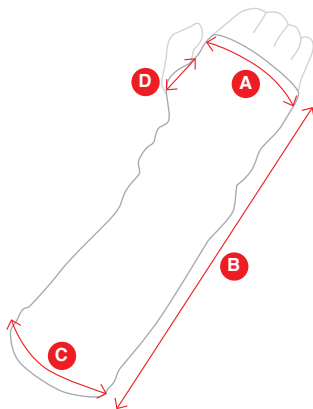

All measurements are taken flat in centimetres. All measurements are approximate and offered as a guideline only.

### Blade Cut Resistance

EN 388:2016 Level 5

EN 388:2016 Level E (TDM-100 Test)

ISO 13997:1999 Level 5

ANSI/ISEA 2016 Level A5

### Tear Resistance

EN 388:2016 Level 4

### Puncture Resistance

EN 388:2016 Level 4

### Abrasion Resistance

EN 388:2016 Level 3

Dimensional Stability Test Achieved excellent results

CE Marking Cat II PPE Directive

Sizes S - XL

Clothing Care Machine washable up to 40° Celsius

Colour Grey

Place of Manufacture EU

	Description	S	M	L	XL
A	Cuff width	9	10	11	12
B	Sleeve length	30	32	33	34
C	Arm width	11	12	13	14
D	Thumbhole opening	6	6	6	6

# Contact

---

**SlashPRO® Slash Resistant Clothing is part of PPSS Group**

## **PPSS Group**

Unit 603  
Avenue D  
Thorp Arch Estate  
Wetherby  
LS23 7FS  
United Kingdom

T: **+44 (0) 845 5193 953**

E: **info@ppss-group.com**

W: **www.ppss-group.com**



Visit our website: [www.slash-pro.com](http://www.slash-pro.com)

T: +44 (0) 845 5193 953 | E: [info@slash-pro.com](mailto:info@slash-pro.com)